



The Concept of the Individual Building Renovation Roadmap

An in-depth case study of four frontrunner projects

BPIE – Buildings Performance Institute Europe
January 2018

www.ibroad-project.eu



This project has received funding from the European Union's Horizon 2020 research and innovation programme under grant agreement N° 754045

Authors (BPIE)

Mariangiola Fabbri
Jonathan Volt
Maarten de Groot

BPIE would like to acknowledge the contribution to this report by the following experts:

Mieke Deurinck (VEA)
Niels Kaare Bruun (BetterHome)
Jean-Noël Geist (The Shift Project)
Peter Mellwig (ifeu)
Benoît Montel (P2E)
Martin Pent (ifeu)
Tine Vande Castele (VEA)

Review and editing team (BPIE)

Marine Faber
Oliver Rapf

External reviewers

BPIE would like to acknowledge the contribution of iBRoad partners in reviewing this report. In particular: Marianna Papaglastra (Sympraxis Team), Rui Fragoso (ADENE), Paulo Liborio (ADENE), Alexander Stankov (EnEffect), Lukas Kranzl (TU Wien).

Graphic design

Sympraxis Team

Cover illustration

stockasso/depositphotos.com

Published in January 2018 by iBRoad.

© iBRoad 2018. All rights reserved. Reproduction is authorised provided the source is acknowledged.

All of iBRoad's reports, analysis and evidence can be accessed from ibroad-project.eu

The sole responsibility for the content of this publication lies with the authors. It does not necessarily reflect the views of the European Commission. Neither the EASME nor the European Commission are responsible for any use that may be made of the information contained therein.

Table of Contents

I. INTRODUCTION	05
i. Methodology	06
II. THE CONCEPT OF BUILDING RENOVATION PASSPORT	07
i. Common barriers to residential renovations	10
ii. Overview of existing cases	10
a. Flanders – Woningpas and EPC+, 11	
b. France - Passeport Efficacité Énergétique, 14	
c. Germany – Individueller Sanierungsfahrplan, 16	
d. Denmark - BetterHome, 17	
III. THE PREPARATION PROCESS	19
i. Initiators	20
ii. Financing	23
iii. Stakeholder involvement	24
iv. Market research and analysis (for design, pilot phase and product improvement)	26
a. Design phase: Testing the general concept, 26	
b. Pilot phase: testing the product to gather feedback and improve the product, 27	
IV. THE ELEMENTS OF THE BUILDING RENOVATION PASSPORT	30
i. The Renovation Roadmap	30
a. On-site visit and energy audit, 30	
b. Measure progress with a selection of performance indicators, 35	
c. Guidance and recommendations, 37	
d. Data gathering. 40	
ii. Logbook	41
a. Functionalities, 42	
b. Data gathering, 43	
c. Ownership and data-privacy, 44	
V. LESSONS LEARNT	46
i. Key success factors	47
VI. REFERENCES	49
VII. ANNEX A: DEFINITIONS	51
i. General definition of deep (staged) renovation	51
ii. Flanders	51
iii. France	52
iv. Germany	52

VIII. ANNEX B: PERFORMANCE INDICATORS FOR THE RENOVATION ROADMAP	53
i. Flanders - EPC+	53
ii. France - P2E	53
iii. Germany - iSFP	54
IX. ANNEX C: VISUAL REPRESENTATION OF THE SELECTED BUILDING RENOVATION PASSPORTS	57
i. Flanders - Woningpas	57
ii. Flanders - EPC+	62
iii. France - Passeport Efficacité Energétique (P2E)	69
iv. Germany - Mein Sanierungsfahrplan (iSFP)	74

I. INTRODUCTION

Roughly 97% of the European Union (EU)'s building stock, amounting to over 30 billion m², is not considered energy efficient, and 75 to 85% of it will still be in use in 2050 [1] [2] [3]. Defining a pathway towards a 'highly efficient and decarbonised building stock by 2050' is a fundamental pillar of the revised Energy Performance of Buildings Directive (EPBD), requiring the transformation of the majority of buildings from highly inefficient to, at least, nearly zero-energy buildings.

This is an opportunity to significantly improve the quality of the building stock and the living conditions of all Europeans. However, to achieve this goal, the multiple barriers building owners face when planning a renovation must be overcome. One of the main barriers to renovation is the lack of knowledge about what measures to implement and in which order. Building renovation is often considered a burden that many associate with time-consuming planning, uncertainty about the value of the planned measures, dust and unreliable professionals.

The iBRoad EU-funded project works on eliminating these barriers by developing an Individual Building Renovation Roadmap for single-family houses. This tool provides a customised renovation plan over a long-term period (10-20 years). The roadmap is at its core a home-improvement plan which considers the occupants' needs and specific situations (e.g. age, financial situation, composition and expected evolution of the household, etc.) and avoids the risk of 'locking-out' future renovation solutions due to a lack of foresight.

The renovation roadmap is combined with a building logbook, a repository where all the building-related information can be stored and continuously updated. The type of information stored in the logbook and its functionalities can evolve over time and could range from energy production and consumption to equipment maintenance, as well as insurance, property plans and obligations, energy bills, smart meter data and links to available financing options for renovation projects (e.g. green loans, incentives, tax credits).

This report offers an overview of the process behind the creation of an Individual Building Renovation Roadmap and covers the key issues that need to be addressed to allow its development and implementation. Real-life examples based on four existing initiatives revolving around the concept of individual building roadmaps and passports are used in this report to demonstrate how the different elements can be designed and implemented: Denmark (BetterHome), Flanders (Woningpas and EPC+), France (Passeport Efficacité Énergétique) and Germany (Individueller Sanierungsfahrplan). These specific cases were chosen for their advanced phase of development; most are entering or have just concluded the testing phase and will soon start implementation. Two of the cases (Germany and Flanders) are driven by (regional) governments, while the others are initiated or driven by private actors (BetterHome in Denmark and Passeport Efficacité Énergétique in France).

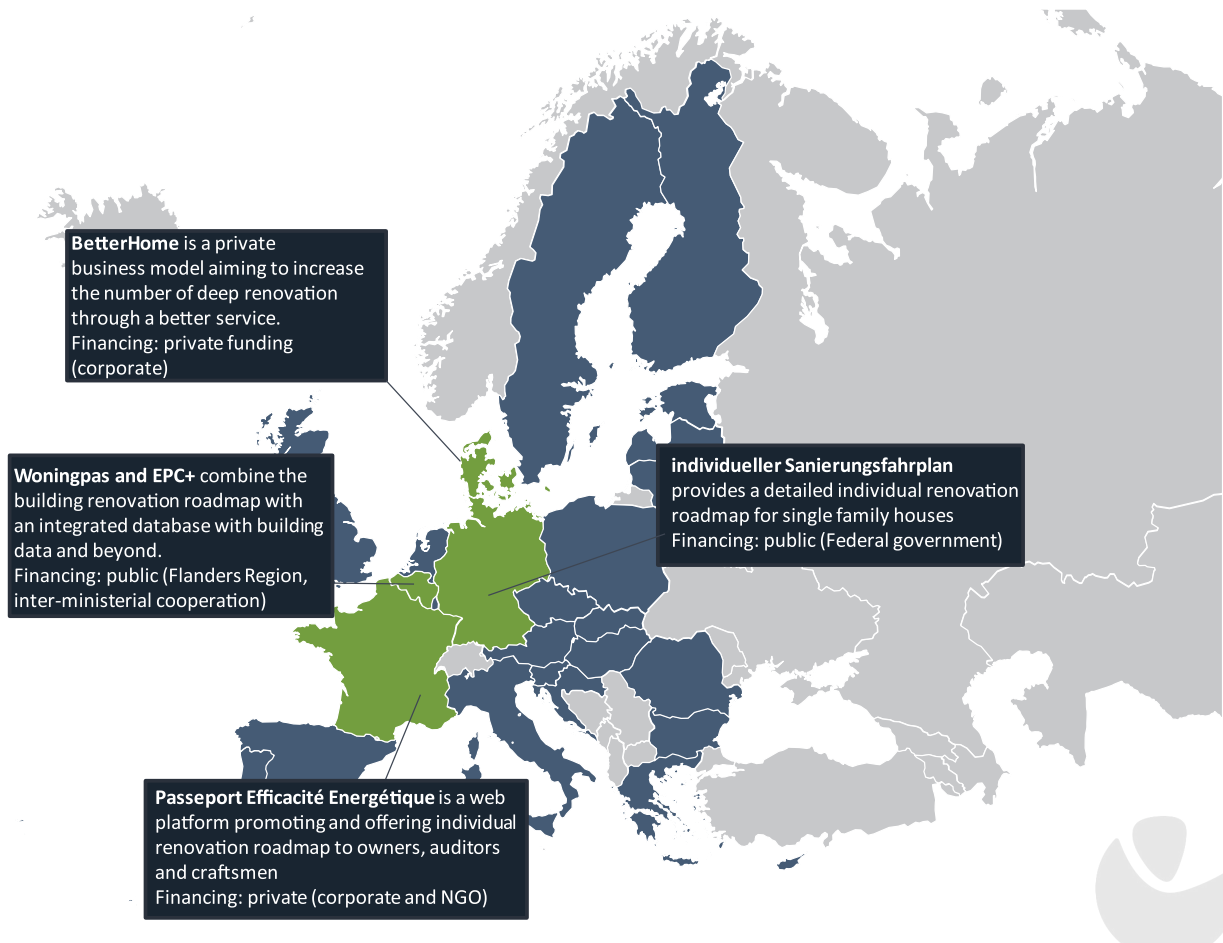

Figure 1: Individual renovation roadmap initiatives currently tested in Europe

i. Methodology

This study is a follow-up to BPIE's publication *Building Renovation Passports - roadmaps towards deep renovation and better homes (2016)*, combining both primary and secondary research. After completing an initial desk-based research to review available literature, identify target examples and map their key features, BPIE interviewed the project managers of each of these initiatives – Niels Kaare Bruun for BetterHome (Denmark), Martin Pehnt and Peter Mellwig from ifeu (Germany), Tine Vande Castele and Mieke Deurinck from the Flemish Energy Agency (Flanders) as well as Benoît Montels from P2E and Jean-Noël Geist at The Shift Project (France) - to understand the key challenges in the development and implementation of each concept. Chapter II provides a concise description of the concept and existing barriers, as well as a brief overview of the four cases.

Chapter III describes how the concept has been developed, including different approaches to stakeholder involvement, followed with the presentation of the different components of the renovation roadmap and logbook, including sections on data gathering and ownership. The concluding chapter highlights lessons

learnt and identifies key recommendations to introduce and implement individual building renovation roadmaps across Europe.

The iBRoad (individual Building Renovation Roadmap) concept includes the individual renovation roadmap and the building logbook, and refers to the research and instruments under development in the Horizon 2020 Programme with the same title (for which this report is developed). To avoid confusion between the project's terminology and the four cases analysed, the four concepts described in this report will be labelled as "Building Renovation Passports".

II. THE CONCEPT OF BUILDING RENOVATION PASSPORT

There is no standard definition of what a Building Renovation Passport is. Every example differs in some elements and in the terminology used. The definitions used in this report are based on the main findings of the cases analysed and could be used to initiate and structure a debate on Building Renovation Passports across Europe. The iBRoad project will further explore the concept, by including a detailed analysis of data accessibility and availability¹, by developing, programming and testing modules and training for auditors.

Figure 2 illustrates the main components of the Building Renovation Passports to provide a common understanding of the terminology and the different elements covered by the examples analysed. The terminology and definitions adopted in each country are described in .

A Building Renovation Passport is defined as a document - in electronic or paper format - outlining a long-term (up to 10 or 20 years) **step-by-step renovation roadmap** for a specific building, resulting from an *on-site energy audit* fulfilling specific quality criteria and indicators² established during the design phase, following a dialogue with building owners. The expected benefits in terms of reduced heating bills, comfort improvement and CO₂ reduction are a constitutive part of the Building Renovation Passport and are explained in a user-friendly way. The renovation roadmap can be combined with a repository of building-related information (**logbook**) on aspects such as the energy consumption and production, executed maintenance and building plans, providing several functionalities to the building owner which could go beyond the energy performance.

On-site data gathering is often the first step towards the creation of a Building Renovation Passport. The data processing can change according to each model (e.g. by using a dedicated software or by adapting the existing energy audit software). Data from EPCs are ideally integrated into the initial data gathering, but are not a requirement. The data gathered in step 1 allow to deliver a comprehensive step-by-step renovation roadmap in step 3 (see Figure 2).

1. D.4.1. Data Mapping: analysis covering the type of data necessary to develop iBRoad, ownership and privacy issues and necessary steps to grant data access

2. E.g. energy consumption, daylighting, indoor air quality, health conditions, thermal comfort, acoustic comfort, cost

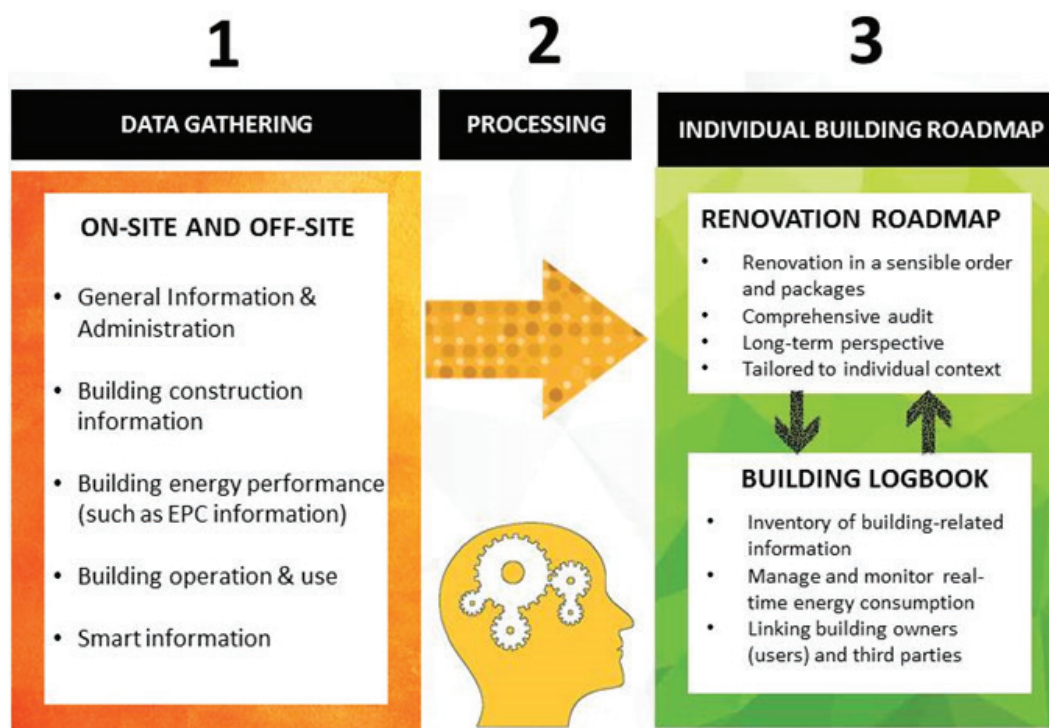

Figure 2: Building Renovation Passport - Overview of its components (Source: BPIE)

The growing interest for the individual Building Renovation Passport (iBRP) is coming from the understanding that better instruments should be available for building owners who are interested in renovating their properties, in order to foster the energy transformation of the building stock. A Building Renovation Passport can be viewed as an evolution of the Energy Performance Certificate (EPC), as it not only indicates the energy performance of a building, but also supports building owners with personalised suggestions on their renovation options. EPCs can be integrated in the Building Renovation Passport, but this is not a required condition. In Flanders, the EPC+ is a continuation of the existing EPC scheme, while in Germany there is no link between the renovation roadmap (iSFP) and the country's EPC scheme.

EPCs were introduced by the first Energy Performance of Buildings Directive in 2002 (2002/91/EC)³ with the aim to make the energy performance of individual buildings more transparent. The EPBD recast in 2010 (2010/31/EU) reconfirmed and strengthened the instrument by introducing an independent quality control of EPCs, penalties for non-compliance, the obligation to display the energy label in advertisements, a mandatory requirement to hand out a copy of the EPC in sale and rent transactions and improvement of renovation recommendations (cost-effective and cost-optimal measures). EU Member States have implemented national EPC schemes, although different approaches about the comprehensiveness and

3. Directive 2002/91/EC and recast: Directive 2010/31/EU, <https://ec.europa.eu/energy/en/topics/energy-efficiency/buildings>

quality assurance provide a very diverse picture of its implementation⁴. To date, the implementation of EPCs varies significantly across Member States in terms of scope and information available, resulting in some cases in limited market penetration or acceptance by the users.

In most EPC schemes, the recommendations for measures improving energy performance are scarce, too general or non-existent. Additionally, EPC-related services, such as energy consultancy and audits for residential buildings, are non-existent or differ significantly among Member States.

The iBRoad project analysed the current use of EPCs and the potential links to individual building roadmaps and logbooks in its eight partner countries⁵. The analysis was based on desk research and qualitative interviews with local experts. The analysis showed that the information in the EPC is rarely perceived as useful for the end-users.

The main outcomes of this analysis are listed below:

- Better and more detailed renovation advice is needed to support the decision-making process for deep renovation than what EPCs currently provide.
- Building owners in general have a moderate understanding of the information contained in the EPCs.
- The EPCs do not increase sufficiently the building owner's awareness about energy performance of the building.
- The main weakness of the current EPC scheme is its high cost compared to the perceived benefits.
- Better compliance and quality would increase the trust in EPCs.
- The recommendations included in the EPC are often considered to be too generic.
- The EPC systems have not effectively tackled barriers to renovations and most experts see the value of a user-friendly instrument providing recommendations for renovation with a longer-term perspective (up to 20 years).
- The experts also indicated a number of characteristics to be included in an iBRP:
 - Recommendations for deep (staged) renovations, including costs.
 - Elements aiming at increasing awareness of the building owner.
 - Straightforward and accessible information.
 - Reliable quantifications of energy savings of potential measures.
 - A link between primary energy use and CO₂ emissions.
 - A centralised database that would store relevant information and provide it to all stakeholders

4. BPIE (2014): Energy Performance Certificates across the EU [1]

5. This was analysed in 8 country factsheets for Belgium (Flanders), Bulgaria, Germany, Greece, Poland, Portugal, Romania and Sweden: "Current use of Energy Performance Certificates in 8 EU countries and potential links to iBRoad". Available at <http://ibroad-project.eu/news/8-country-factsheets/>

i. Common barriers to residential renovations

In the four cases analysed in this report, the instruments were developed to support building owners with better guidance and information about options for energy renovations, and by doing so, to increase the demand for deep (staged) energy renovations. In all cases, the concept was developed in cooperation with key stakeholders. While the focus among the different cases differs depending on context and ambition, the identification of existing barriers to renovation is a common initial step. Most of the barriers identified are recurring:

- **Uncertainty and lack of knowledge** regarding where and how to start the renovation process, which measures to implement and in which order to implement them.
- **Complex processes** and mixed quality of works offered by building professionals.
- Difficulty to **access finance** and lack of awareness of available financial support (e.g. subsidies, loans, tax credit/incentives, etc.).
- **Insufficient training** for auditors beyond technical aspects, to improve communication with building owners (e.g. effective communication, project management, life-cycle approach).
- **Complexity** of existing tools, EPCs and energy audit reports are in general hard to understand for the majority of building owners.
- A limited follow up after an energy audit or the issuing of an EPC create **no incentive or pressure to renovate**.
- **No quality control** mechanisms and certification of works. The lack of checks contributes to the gap between designed and actual performance.

ii. Overview of existing cases

Table 1 provides a general overview of the key features of a Building Renovation Passport and describes whether each of the four concepts includes them. While each case differs in how specific needs and conditions are considered, most features are included in each case (e.g. long-term target for building renovation, identified barriers, stakeholder mapping and engagement, tailored solutions, etc.), or are under consideration. It is important to note that the logbook, which is one of the components of a Building Renovation Passport, is only fully developed so far in Flanders⁶.

6. Germany will test the logbook as part of the iBRoad project

Process	BE-Flanders (EPC+)	France (PEE)	Germany (iSFP)	Denmark (BetterHome)
Definitions (Deep or staged deep renovation and/or alternative definition)	✓	✓	✓	✗
Long-term target for the existing building stock (2050)	✓	✓	✓	✗
Identified barriers	✓	✓	✓	✓
Stakeholders mapping	✓	✓	✓	✓
Stakeholders engagement	✓	!	✓	✓
Market analysis	✓	✓	✓	✗
Energy Audit – On-site visit	✗	✓	✓	✓
Auditors training	✗	✓	✓	✓
Tailored solutions (renovation roadmap)	!	✓	✓	✓
CO ₂ reductions	✓	!	✓	✓
Logbook/Database	✓	!	✗	!
Integrated financial support	!	N/A	✓	!

✓ = Yes ! = Under development/consideration ✗ = No

Table 1: Overview of key features in the four cases

Each model is described in more details below.

a. Flanders – Woningpas and EPC+

The Flemish Energy Agency (VEA), in cooperation with a wide network of stakeholders, has designed and implemented the “Renovation Pact” (2014-2018), designed to lead to a thorough improvement of the energy performance of the region’s building stock. Flanders established that by 2050 the existing building stock should become as energy-efficient as the current requirements for new buildings (E60⁷).

One of the main actions foreseen in the Renovation Pact is to develop the Woningpas (a logbook) and the EPC+ (a more user-friendly version of the EPC, including a clear overview of measures, ordered by priority,

7. According to Flanders’ energy efficiency legislation (EPB), requirements in terms of insulation and ventilation are set and the overall energy efficiency of a new home is classified according to the so-called E-standard, with a low standard indicative of a highly energy-efficient home. The standard for new buildings in 2016 is E60, corresponding to a primary energy demand for new and non-residential buildings of 100 kWh/m²/y.

needed to reach the 2050 objective). The two instruments aim to provide building owners with useful, easy-to-understand information and long-term guidance. Through these instruments, the public authorities in Flanders also intend to contribute to the region's long-term objectives.

The **Woningpas**⁸ is a unique integral digital file of each individual building. The file can be retrieved by the building owner and by individuals who have been authorised access. The logbook features energy performance, renovation advice, the housing quality (such as stability, humidity, safety), data on the environment and in the future other building aspects such as durability, water, installations and building permits. The Woningpas will make it possible to track the evolution of each individual building.

A first version of the Woningpas (*Woningpas Light*) will be launched in 2018, followed by a series of upgrades in the following years (*Woningpas Medium* in 2019, *Woningpas Full* in 2020 and further updates after 2020).

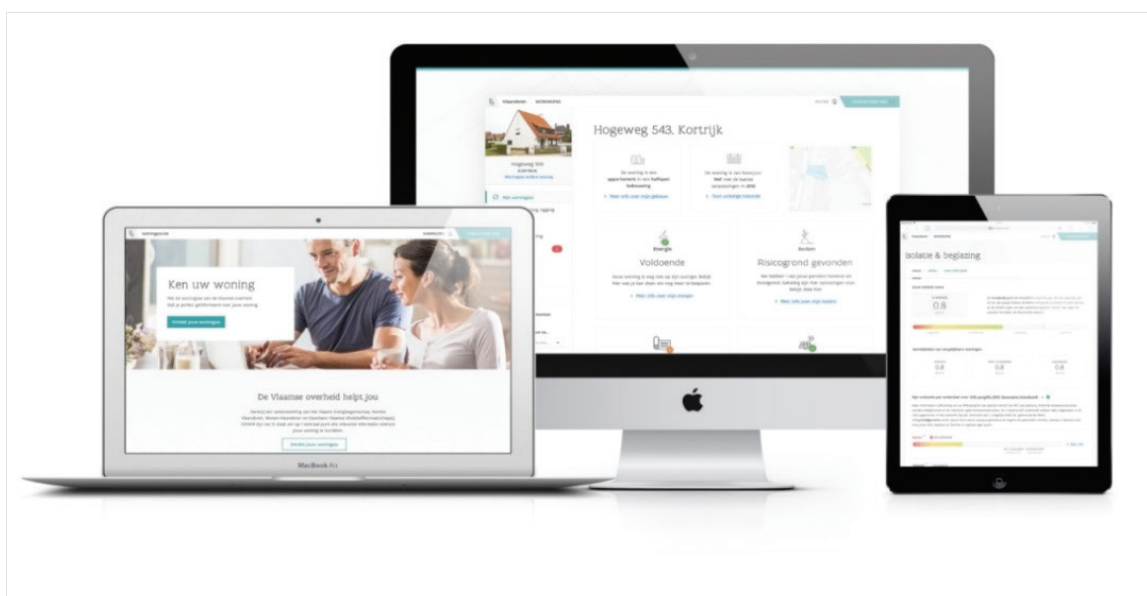

Figure 3: Look and available applications of the Flemish Woningpas, as expected in 2018
(Source: Flemish Energy Agency)

⁸ Woningpas is best translated as 'dwelling ID' or 'dwelling passport'

The **EPC+** is the successor of the current Energy Performance Certificate scheme, to be expected on January 1st, 2019. The EPC+ will include a renovation advice and will outline the actions the building owner should take in order of priority to bring the current energy performance of the property to the level of the long-term objective. The tool includes recommendations for various elements that accompany a thorough renovation (airtightness, ventilation etc.), provides a selection of technical information to avoid lock-in effects. No recommendations are provided if the building fulfils the long-term objective.

The energy expert develops the EPC+, including the renovation recommendations, through an on-site visit. Each individual dwelling can choose the criteria to use to measure its contribution to the long-term objective:

Energieprestatiecertificaat

Bestaand gebouw met woonfunctie



Figure 4: The Flemish EPC+ (front page), as expected in 2019
(Source: Flemish Energy Agency)

Option A	Primary Energy Consumption (kWh/m ² /year)	The whole building	100.00
Option B	Heat Transfer Coefficient (U-Value = W/(m ² K))	Roof	< 0.24
		Walls	< 0.24
		Floor	< 0.24
		Windows (glazing and profile)	< 1.10
		Efficient heating system	1.00

Fact Box

Targeted building typology: Mainly Single-Family Houses and individual apartments

Link with the country's long-term objectives: Yes, the target for the building stock by 2050 is an average primary energy consumption of 100 kWh/m²/year

Link with financial instruments: Not in the EPC+ or the Woningpas light. The Woningpas medium will link the recommendations with the financial incentives available (e.g. prime lending rates, subsidies, tax credits, energy loans). It will, however, not include mortgage loans or insurances.

Training of energy experts: No additional training is required for the energy experts. The current EPC experts will gather the required information to develop the EPC+ certificates.

b. France - Passeport Efficacité Énergétique

The concept for the Passeport Efficacité Énergétique (P2E) was developed by the Shift Project⁹ together with a group of building specialists and professionals, between 2012 and 2014. The objective was to unlock the thermal renovation of residential buildings, identified as an imperative step towards decarbonising the economy¹⁰. Testing and implementation are assigned to Expérience P2E, a not-for-profit organisation created for this purpose¹¹. The review below is based on a series of documents provided by the Shift Project and Expérience P2E, and a series of exchanges with Expérience P2E's Project Leader.¹²

Building upon the notion of “energy efficiency reflex”, P2E suggests a pragmatic approach to maximise the opportunities to trigger energy renovation every time maintenance work is done in a building¹³. Using any type of renovation or maintenance work as a trigger to install energy-renovation measures helps promoting energy efficiency among building owners and professionals and may generate higher levels of renovation.

The passport provides a set of solutions (“performance combinations” in Figure 5), based on the combination of simulations established according to specific features like building type, age, climate (etc.) that would allow to reach the BBC and SNBC level¹⁴ for the overall building stock. Each building is considered as one “piece of the puzzle” contributing to the overall 2050 target (BBC 2050, equivalent to 80kWh/m² of primary energy per year). These combinations aim at providing a set of consistent solutions for all parts of the building, which, taken together, support the realisation of the final goal. By simplifying the choice among possible solutions for the renovation and making it easier for the building owner, the system aims at “industrialising” the renovation process and achieving economies of scale.

9. The Shift Project is a French think-tank dedicated to identifying the step changes required to address the challenges of energy and climate and to developing and sharing resources, proposals and solutions to address them

10. The Shift Project (2013) : “Performance Énergétique du Bâtiment - Programme de rénovation thermique du parc existant 2015) [1]

11. <http://www.experience-p2e.org/>

12. Benoît Montels (P2E Project Leader), interviewed on July 26, 2016 and December 6, 2017

13. Ensuring that roofs and façades are meeting energy requirements when these are renovated for aesthetic or other reasons (e.g. equipment replacement) is now part of the regulation (Loi de Transition Énergétique et de Croissance Verte, 2015).

14. BBC (Bâtiment Basse Consommation) is a low energy building renovation to be achieved by 2050. In 2015, the Energy Transition Act (Loi de Transition Énergétique et pour la Croissance Verte, LTECV) established that the French building stock should reach nZEB level by 2050, when all buildings must be in class A or B (based on the French EPC).

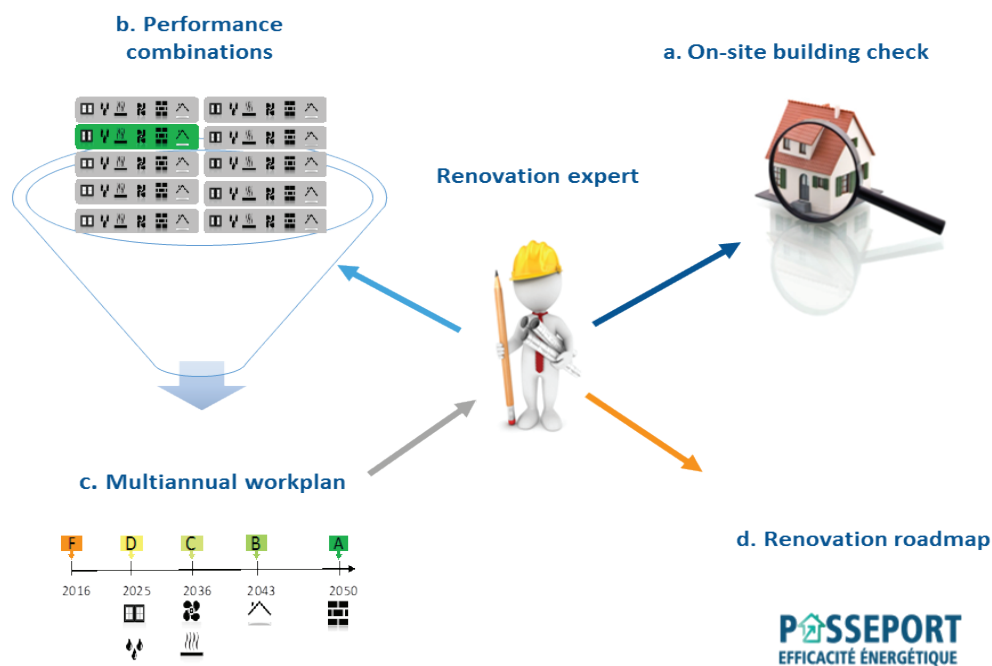

Figure 5: P2E process to develop the individual renovation roadmap (Source: Expérience P2E)

Fact Box

Targeted building typology: Mainly Single-Family Houses

Link with the country's long-term objectives: Yes. By 2025, all class F and G buildings must be renovated. Improvements should be close to the performance of a new building. By 2050, all buildings must be in class A or B (based on the French EPC), reaching BBC levels or equivalent (BBC levels of renovation by 2050 is equivalent to 80kWh/m² of primary energy per year, including heating, hot water and cooling).

Link with financial instruments: The passport can be linked to financing opportunities, including subsidies, incentives, tax credits, etc. and incentives available at local, regional and national level, but this function is not activated yet.

P2E intends to cover availability of public national programmes first. The organisation is aware of the difficulty of keeping the information up-to-date over time.

Training of energy experts: A demonstration of the passport application has been conducted. A "passport training" for auditors and building renovation companies is under consideration.

c. Germany – Individueller Sanierungsfahrplan

The concept of Sanierungsfahrplan (SFP) was initially developed and tested by ifeu and ECONSULT in the federal state of Baden-Württemberg in 2011-2013 and officially launched in 2015. The Sanierungsfahrplan BW¹⁵ is an energy audit instrument, publicly funded by the State Bank (L-Bank) and carried out by certified energy auditors. It can also serve as a partial fulfilment of the Renewable Heating Obligation of Baden-Württemberg.¹⁶ Besides residential buildings, the official decree defining the Sanierungsfahrplan, the Sanierungsfahrplan-Verordnung SFP-VO, also defines requirements for a Renovation Roadmap for non-residential buildings.¹⁷

A newly developed Individueller Sanierungsfahrplan (iSFP) was launched at the national level in 2017. The iSFP is part of the National Energy Efficiency Programme¹⁸ and of the "Federal Efficiency Strategy for Buildings" (ESG) published in December 2015¹⁹. Ifeu (Institute for the Energy and Environmental Research), DENA (the German Energy Agency) and the Passivhaus Institute (Passive House Institute) were in charge of the project, in collaboration with the German Ministry of Economic Affairs and Energy (BMWi).²⁰

In Germany, EPCs are not considered reliable enough to stimulate renovation and are often viewed as an administrative obligation. On the other hand, there is a strong culture of on-site energy auditing, but the very detailed reports delivered to building owners (up to 150 pages) are often left unread and do not promote staged renovations. Since July 1, 2017, the iSFP is accepted as audit report within the federal Office for Economic Affairs and Export Control (BAFA) support programme "Energieberatung vor Ort". This programme grants subsidies of up to 60% of the cost for an on-site audit (maximum €800 for single- and two-family buildings, and up to €1100 in buildings with three or more dwellings).

The iSFP has been designed to be a user-friendly tool that includes both short and long-term measures and suggests ways to avoid lock-in effects. As about 85% of the energy renovation measures funded in Germany concern only one building component, iSFP puts a strong focus on staged renovation and the interdependences between the stages. Behind this tool is the idea that building owners must be given the appropriate means to turn renovation from "a nuisance that I have to endure" (I have to renovate) into "an opportunity to improve my house and my living environment" (I want to renovate).

15. <https://um.baden-wuerttemberg.de/index.php?id=8110> (Access 19th January 2018)

16. In Baden-Württemberg, home owners have to use 15 % renewable heat when they replace an existing boiler. This obligation can be reduced to 10 % when a renovation roadmap is prepared.

17. https://um.baden-wuerttemberg.de/fileadmin/redaktion/m-um/intern/Dateien/Dokumente/5_Energie/Beratung_und_Information/SanierungsfahrplanBW/VO_Sanierungsfahrplan.pdf

18. 3rd National Energy Efficiency Action Plan (NEEAP) 2014 for the federal Republic of Germany, https://ec.europa.eu/energy/sites/ener/files/documents/2014_neeap_en_germany.pdf

19. <http://www.bmwi.de/English/Redaktion/Pdf/energy-efficiency-strategy-buildings,property=pdf,bereich=bmwi2012,sprache=en,rwb=true.pdf>

20. Bundestministerium für Wirtschaft und Energie (BMWi)

Fact Box

Targeted building typology: Mainly single-family houses and smaller multi-family houses.

Link with the country's long-term objectives: The guideline for the iSFP builds on the "best-possible-principle", implying that each building's renovation roadmap should be as ambitious as possible. Auditors must recommend the best solution to achieve the efficiency level established on average for the building stock and justify any deviation from the best standard.

Link with financial and regulatory instruments: The iSFP is accepted as report in the federal on-site audit funding programme. Linking with KfW funding is also being considered.

Training of energy experts: Auditors participating to the iSFP receive a handbook where every step of the iSFP is described in detail. The on-site audit programme requires the auditors to have a qualification and attend a specific training offered by accredited organisations. This training will also include training on the renovation roadmap and related issues. For example, the energy auditors might be offered training sessions on new technical and communication skills to successfully implement the iSFP and the "best-possible-principle".

The objective is to help auditors acquire the ability to design a comprehensive package of measures to achieve deep renovation considering the owners' specific needs, communicate easily with the building owners and successfully nudge them to initiate deep renovations.

d. Denmark - BetterHome

BetterHome is an innovative business model initiated by four major building-component manufacturers in Denmark (Danfoss, Grundfos, Rockwool and Velux). While it is not a building renovation roadmap per se, the model shares many of its characteristics (user-centric, focus on deep renovations, adapting the role of installers, focuses on multiple benefits and innovative technologies).

BetterHome is an industry-driven one-stop-shop model, which has proven successful in boosting demand for holistic energy renovations in Denmark since its launch in 2014. It was profitable after just three years, with 200 projects in 2016 and is expected to continue its growth. The success of the home-owner-centric business model can be explained by the advanced service-oriented role of the installers. BetterHome trains and guides the installers on how to approach the home-owner, from the first contact to the finalisation of the process. BetterHome also simplifies and structures the renovation process for the installer, through supportive and innovative digital tools, enabling a better process for everyone involved.

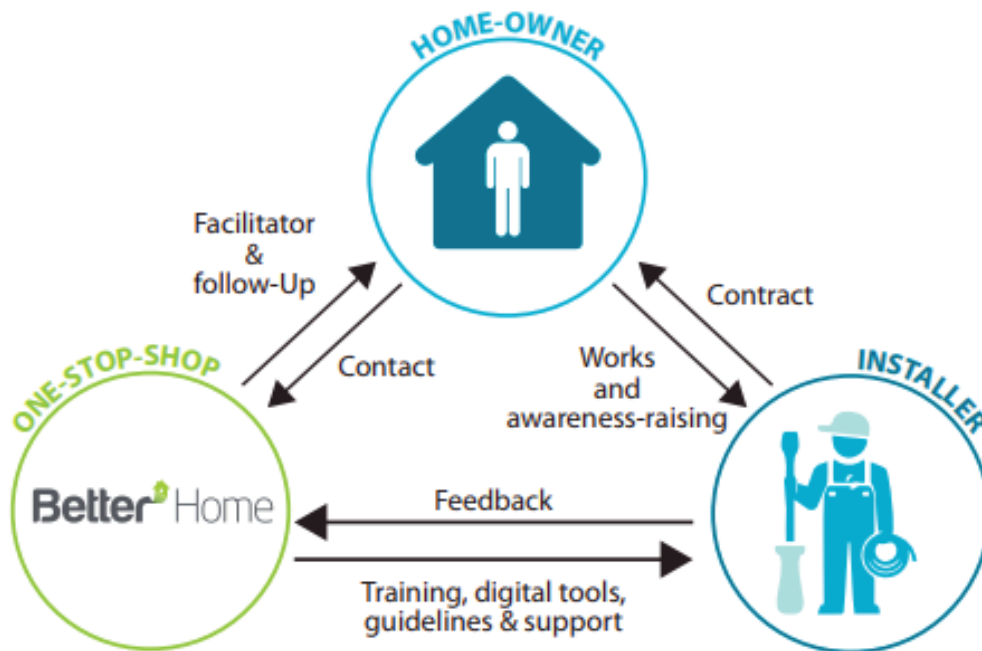

Figure 6: BetterHome's facilitator role in the renovation process (Source: BPIE)

Fact Box

Targeted building typology: Mainly single-family houses. The model was recently extended to apartment buildings and commercial buildings.

Link with the country's long-term objectives: No, the model aims to increase the renovation rate and depth and is only indirectly supporting the country's objectives.

Link with financial subsidies: Yes, financial subsidies can be integrated into the model.

Training of energy experts: BetterHome trains all its installers conducting the on-site visit on how to approach the home-owner. Part of the installers' training focuses on how to address potential customers and get them to realise the full value of energy renovations (e.g. increased indoor comfort and air quality).

III. THE PREPARATION PROCESS

Setting up a Building Renovation Passport requires substantial effort, including concept design, stakeholder involvement, market analysis, software development, legal and financial preparations, and expert training. Two initiatives (Germany and Flanders) were initiated by public authorities, while in France and Denmark they were initiated and developed by private actors.

This chapter describes the four key stages for the development of a Building Renovation Passport and how they were carried out in each case (Figure 7). The first section describes (i) how the concept was initiated, followed by (ii) financial planning, (iii) stakeholder engagement, and (iv) market research analysis.

The order in which each stage is implemented can vary from case to case, so Figure 7 should be regarded as a checklist rather than a step-by-step guide.



Figure 7: 4 key stages for setting up a Building Renovation Passport

As Figure 8 shows, at least 2 to 3 years pass between the beginning of the process and the implementation (including a testing phase). The time required to complete the testing and start implementation depends on several factors including: nature of the initiator (public/private), budget available, scope of the project, size of the testing phase, adjustment needed between testing and launch of product on the market. Testing can be done on a small scale before it is properly launched, or it can be designed in several phases to adjust the product over a longer period. Different elements of the Building Renovation Roadmap can be tested, issues and potential improvements can be identified and solved before the full-scale launch. All the cases in this report used small-scale testing at the design or pilot phases.

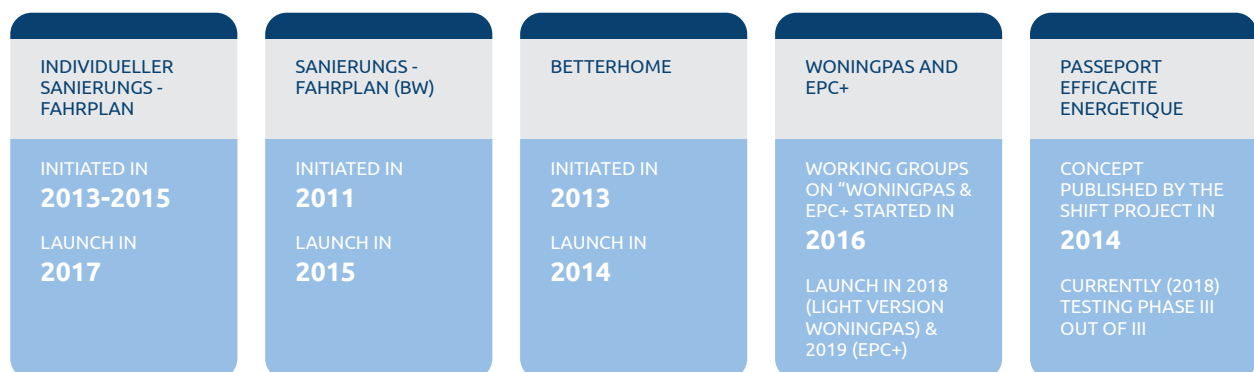

Figure 8: Time span between concept design and launch

i. Initiators

Building Renovation Passports can be initiated by different actors. Depending on local circumstances, the process can be launched by either public or private actors. For example, the Woningpas and EPC+ were initiated by the public authorities in Flanders. The P2E was initiated by an association of NGOs and private companies in France, while the Danish BetterHome was started by private companies (four building-component manufacturers). Future initiatives could spring from different combinations.

The main types of potential initiators are listed below:

- **Public authorities.** The Building Renovation Passport can be an instrument to support a desired policy outcome (e.g. mitigate climate change, improve living standards, generate local jobs, spur innovations, etc.). Launching a Building Renovation Passport with support from public authorities comes with some advantages, for example the ability to link the tool with other public instruments (e.g. financial subsidies, tax credits or mandatory requirements) and an incentive to privilege quality over profit. It also comes with potential disadvantages, like longer time needed for implementation and being linked to election and public budget cycles.
- **Private companies.** A Building Renovation Passport can also be initiated and managed by private companies. The main benefits of an instrument initiated by private actors are the expertise in creating a competitive product as well as a better knowledge of the market and the target group. One of the main challenges in this case is to guarantee a sense of neutrality to build trust among customers.
- **Mixed model.** It can be a public-private partnership (a long-term contract between a private party and a government entity, for providing a public asset or service). This model can combine the benefits of the other two options and take advantage of what the public authorities and the private actors do best (e.g. market analysis, quality control, coordination with other instruments). Non-governmental organisations, think-tanks, as well as research organisations can also be part of the mixed model. To ensure the functioning of the mixed model, it is important to establish clear governance rules, including monitoring and evaluation mechanisms to maintain the balance of power between the two parties.

EXAMPLE

Public authorities

The iSFP was first developed and launched in Baden-Württemberg in South-West Germany. Its local success caught the interest of national policy-makers who planned a nation-wide implementation. The local authorities in Baden-Württemberg (Ministry for the Environment, Climate Protection and Energy), which first developed and tested the Sanierungsfahrplan (SFP-BW) were frontrunners in pushing the idea of an individual renovation roadmap forward. The SFP-BW was first suggested by ifeu in a study on the prospects of the Renewable Heating Law and subsequently developed and implemented by ifeu and ECONSULT in cooperation with the Ministry. The "Individueller Sanierungsfahrplan" (iSFP) was a totally new development for the whole country. This was necessary because SFP-BW had evolved from originally being a local funding programme for the optimisation of heating systems granting only lower subsidies, carried out mainly by craftsmen.

The federal iSFP is based on a more sophisticated on-site audit funding programme which is mostly offered by professional auditors (mainly architects and engineers). It was officially launched by the Federal Ministry for Economic Affairs and Energy (BMWi) in 2017. A pilot testing ran until end of 2017, including 17 renovation roadmaps being developed. Simultaneously, software providers are launching renovation assistants, which allow a simple realisation of the roadmap in the calculation software. The instrument evolved from the Sanierungsfahrplan-BW, and first components were developed in a series of reports by ifeu, IWU and Ecofys from 2013 to 2015²¹. In a second phase, it was refined in a project carried out by ifeu in cooperation with the Federal Office for Economic Affairs and Export Control (BAFA), the German Energy Agency (dena), and the Passive House Institute (PHI).

The Sanierungsfahrplan in Baden-Württemberg is currently being evaluated and results are not available yet. The evolution from the Sanierungsfahrplan BW to the iSFP included the development of some additional elements. Due to its nature (streamlined audit carried out by craftsmen), the Sanierungsfahrplan BW is only a 6-page document reporting the most important data and information for the respective measures. The federal iSFP consists of a summary report with 6 pages as well, but also a very detailed "Umsetzungshilfe" (Implementation guide) which includes detailed photographs and sketches, a more refined analysis of the economy of the potential measures.

EXAMPLE

Private companies

BetterHome was created by the technology and building material manufacturers Danfoss, Grundfos, ROCKWOOL and VELUX in 2014 to offer a better renovation service to the customer. BetterHome operates as an autonomous organisation but owned by the four companies. To deliver an all-inclusive one stop-shop solution, the organisation is partnering with key players in the construction value chain, financial institutions, utilities, local governments, real-estate agencies and building professionals. The model has been active since 2014 in Denmark and was recently launched in Sweden. BetterHome is currently aiming to expand its main scope from single-family buildings to also include multi-family buildings.

21. <https://www.ifeu.de/projekt/weiterentwicklung-des-bestehenden-instrumentariums-fuer-den-klimaschutz-im-gebaeudebereich/>

EXAMPLE

Mixed model

The concept of Passeport Efficacité Énergétique was developed by the Shift Project following a consultation process involving building experts and professionals. The concept is being tested and will be implemented by Expérience P2E, a not-for-profit organisation founded for this purpose in 2016. The founding members of Expérience P2E are the Shift Project, Cercle Promodul, EDF, Saint-Gobain and Schneider Electric (see Figure 9). The organisation works closely with national and regional authorities (e.g. ADEME, ministries of housing and energy, East region of Alsace Champagne Ardenne and Lorraine) and private partners (effinergie, associations Qualitel and Promotelec) through a series of dedicated committees and workshops (ateliers thématiques) to ensure that the Passeport Efficacité Énergétique meets both market needs and long-term policy objectives for renovation.

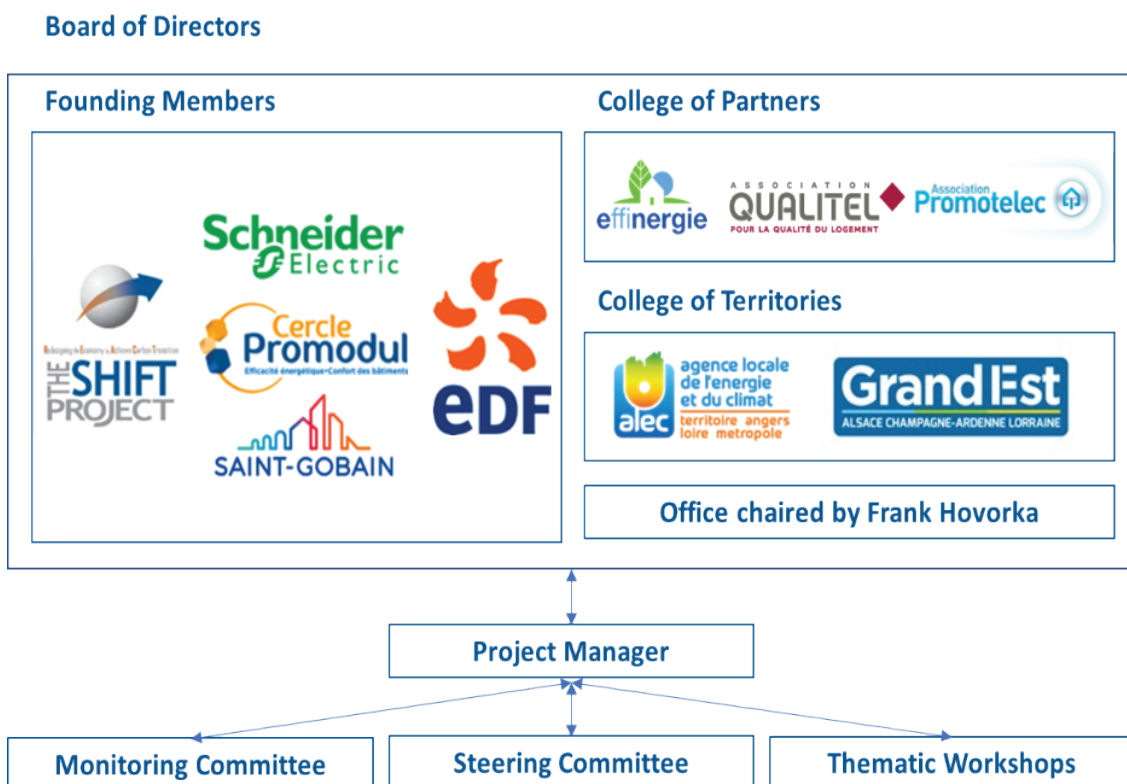

Figure 9: Expérience P2E organisational structure (Source P2E)

ii. Financing

The development and implementation of new instruments require sustainable funding from public or private sources to ensure the necessary funds for the design, testing and implementation of the project are available. This type of funding can take different forms (full public funding, private funding or a combination of the two). The four cases show that different financial paths are possible.

Public funding:

- Germany: the development of the State renovation roadmap was funded by the Environmental Ministry UM in Stuttgart, Baden-Württemberg. A funding scheme supports the preparation of the Sanierungsfahrplan-BW with approximately 200€ per audit. This programme is managed by the L-Bank (the State Bank of Baden-Württemberg). Design and testing of the federal iSFP were carried out on behalf of the federal Ministry of Economic Affairs and Energy (BMWi). The Ministry is also in charge of the funding programmes for on-site audits, energy renovations and renewable energies.
- Flanders: the cost for setting up the instrument is carried by the Flemish government. Thanks to an inter-ministerial co-funding involving four Flemish administrations (VEA, OVAM, Omgeving Vlaanderen and Wonen Vlaanderen)²² the funds for the Woningpas are guaranteed until the release of the Woningpas Medium (in 2019). With the contribution of the Flemish government for 'Vlaanderen Radicaal Digitaal', Flanders elaborated a finance contract for the design and IT-development of the Woningpas for 5 years (2017-2022), that other partners of the Flemish government can join. The administration is also developing a governance model so that other partners can join the collaboration for data collection (development and maintenance), including a financing model.

Private funding:

- France: the costs for the design and testing of P2E in France were covered by private actors: the Shift Project initially introduced the concept and a group of private companies agreed to provide seed funding for the creation of an association (Expérience P2E) in charge of developing the design and testing the concept. Several funding options are discussed to further develop the passport and integrate it in the territories but it is still unknown how funding will be guaranteed in the future.
- BetterHome was financed by private actors with a commercial incentive to increase the rate of (deep) renovation, and grow the demand for their products. No public support has been granted to this project. The financial model of BetterHome is very simple: there are no payments between BetterHome and the installers or the building owners. BetterHome receives its whole budget from Danfoss, Grundfos, the ROCKWOOL and VELUX Groups, who, in return, retrieve indirect sale revenues.

22. VEA is the Flemish Energy Agency, OVAM is the Flemish Public Waste Agency, Omgeving Vlaanderen is the public administration responsible for environment and Wonen Vlaanderen is the public administration responsible for housing.

iii. Stakeholder involvement

The building renovation value chain comprises numerous actors, from building owners, architects, engineers, public authorities, energy suppliers, manufacturers, financial institutions and many more. A new instrument potentially impacting the whole value chain, such as the individual building renovation roadmap, requires the involvement and support of multiple actors and stakeholders to ensure a proper design and an effective implementation. All the cases have, to a different extent, engaged with stakeholders to ensure an effective implementation of the instruments.

The stakeholder involvement is generally used for two purposes: (i) shape the concept and gain support for the implementation and (ii) map and find solutions to lift potential legal and administrative barriers. The second point also includes the involvement of potential data providers to increase data availability (e.g. renovation costs).

Shaping the concept and gaining support

Thought leaders and involved actors from public authorities, civil society (e.g. building owners) and the private sector play an important role in creating and designing the concept. Co-creation and involvement of the main actors early in the process increase the chance of acceptance and support for the instruments, with co-ownership of the process as ultimate aim.

It is crucial for the stakeholders to be convinced of the added value of their involvement, for them to actively participate from the very early stage of the process and to the concept design. Relevant stakeholders ought to be informed about the idea of developing such an instrument and be convinced their participation is important.

When the SFP-BW was first introduced in Baden-Württemberg in Germany, stakeholders were engaged and actively cooperated in the pilot project. Three large stakeholder workshops were organised, including craftsmen, architects, the association of building owners, auditors, policy-makers and NGOs. Software companies were also invited to a roundtable discussion. The approach chosen for the national iSFP was similar to the one adopted in Baden-Württemberg. In addition to large workshops with a broad range of attendants, smaller specific workshops were organised, e.g. with software providers or auditors. The development of the national iSFP was accompanied by a market research study. It was carried out by the German companies' initiative for energy efficiency (Deneff) on behalf of the federal Ministry of Environment.

In France, stakeholders are organised in three committees based on competences and skills: a monitoring committee (comité de suivi), a steering committee (comité de pilotage) and thematic working groups (ateliers thématiques). Thematic working groups run in parallel and they don't meet on a regular basis. The main objective is to familiarise with the Passport, collect the input of the experts testing the passport, integrate it in the subsequent version and simultaneously understand the perspectives of other relevant actors and users.

In Germany, a stakeholder dialogue was also used to assess the level of acceptance of the new tool. The refusal of building owners to engage in deep renovation and to use the iSPF could undermine the success of the initiative. For this reason, putting building owners at the centre of the project and offering an attractive, user-friendly tool are considered two key elements for the success of the iSPF.

In Flanders, VEA followed a similar approach and invited all relevant stakeholders to join the Renovation Pact working groups to develop the concept from the process early stages. The aim of these working groups was to create a support network of co-operating partners who will take care of forwarding the information and action plans to the people connected with the building process to gain project acceptance. Beside stakeholders from the building sector, such as construction and architect federations, a broader set of stakeholders was also involved, such as social housing sector, financing and research institutes, energy distributors, human rights organisations, etc.

Map potential legal and administrative barriers and find solutions to overcome them

Mapping out the legal and administrative framework early in the process is essential to avoid redundant work (e.g. working on a feature that is legally impractical or performing a task which is under the competence of another department). This preparatory work is linked with an effective data gathering and management, which is vital to the concept of both the roadmap and the logbook. A preliminary analysis of the existing legal and administrative framework will help to:

- a. identify key actors in the public and private sectors whose support and contribution could be essential for the implementation and success of the concept (e.g. getting authorisation from specific commissions and committees to exchange information and to use it);
- b. map the data and information needed to feed the renovation roadmap and the logbook, such as energy consumption, databases for renovation prices, cadastre-related information, technical manuals, etc.;
- c. identify the owner(s) of this data (building owner, public authorities, financial institutions, energy utilities, construction federations, etc.);
- d. define if the data is available and how it can be accessed²³; and
- e. define actions to adapt the legal framework (e.g. adoption of decrees, decisions, etc.).



Figure 10: Stakeholder event organised by VEA

23. Points b) to d) will be explored in detail in a specific in task 2.4 "Mapping Data Indicators" of the iBRoad project

In Flanders, representatives of federal and regional legal services were consulted to give advice on data sharing, protection and obligations of building owners. Government agencies at regional, federal and local levels that manage buildings data in Flanders are also regularly consulted. Several working groups were formed (user experience design, technical realisation, communication and juridical service) and meet monthly with all the governmental agencies involved in the project. In addition, notaries, federation of real-estate agencies and representatives of federal legal services are also involved to give advice on data sharing, protection and obligations of building owners. Consultations with government agencies (local, regional and national) that manage buildings data were conducted to assess which kind of functionalities the Woningpas could offer. Energy distributors (Eandis and Infrax) also have an important participative role, since they manage the energy consumption data, coordinate the subsidies and are setting up other actions related to energy savings in buildings. During the development of the EPC+, several user tests have been conducted to present prototypes of the EPC+ to members of the public (the end users of the EPC+) and to gather feedback to further refine and improve the EPC+.

iv. Market research and analysis (for design, pilot phase and product improvement)

When developing a tool for a target clientele, it is important to understand their behaviour, their preferences and their decision-making process. A market research and analysis (on-line or phone survey, focus groups, in-depth interviews etc.) can be performed at various stages of the process: before developing the concept (what would the end-users like to see?), during its design and for testing purposes both during the pilot phase (is the renovation roadmap useful for the user? Does it need adjustments?) or before releasing the product on the market²⁴.

a. Design phase: Testing the general concept

At the beginning of the process, VEA organised a public survey to test the general concept. A second survey was organised to gauge public reactions (Figure 11) about the content of renovation advice, the EPC+ and to enquire about the logbook features (e.g. costs - range/indication/type). The survey helped determine if some elements that could be part of the renovation advice (ex. indication of costs) could be included in the logbook.

24. The iBRoad project foresees a market research to understand the profile of the iBRoad potential users (Task 2.3 "Mapping User Profiles")

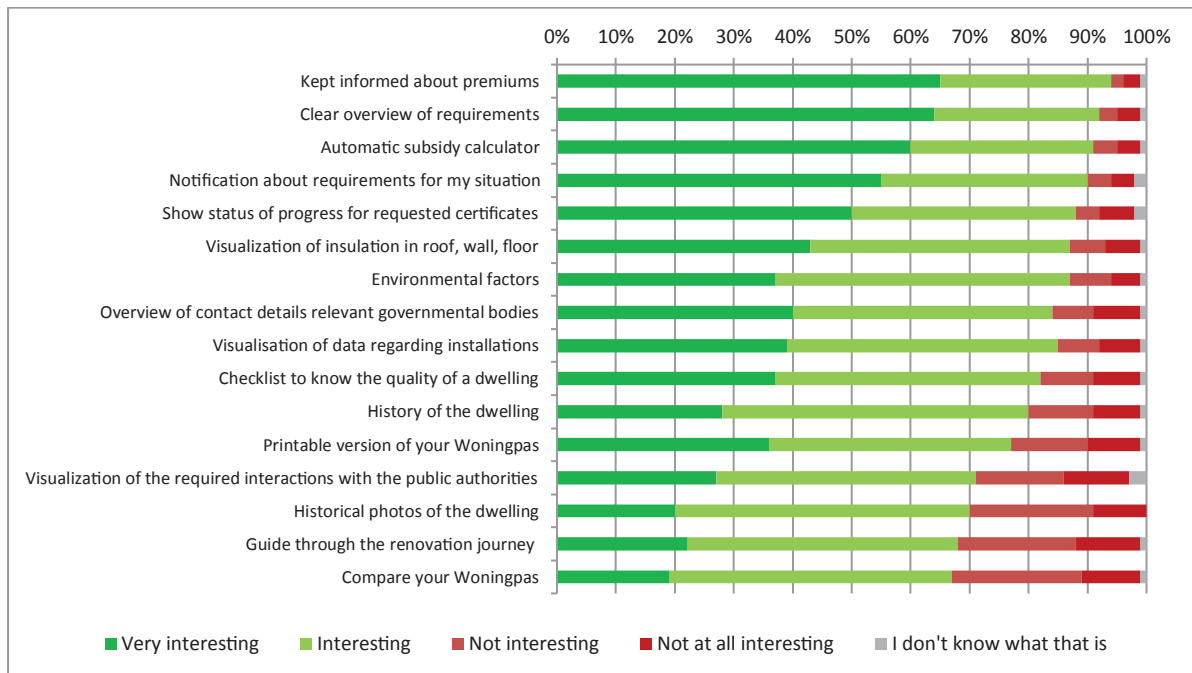

Figure 11: Questionnaire results on which functionalities stakeholders would like to see in the Woningpas
(Source: Flemish Energy Agency)

Along with the development of the federal iSFP, a market research study was carried out by the German companies' initiative for energy efficiency (Deneff) on behalf of the Ministry of Environment and Building. It consisted mainly of three focus group interviews. Up to ten building owners who had carried out energy refurbishments in their homes recently were interviewed. They were asked about their experiences during the renovation phase and what kind of audit would have been helpful for them to plan the measures. Building owners were also asked if a tool like the iSFP could have helped. The questions asked were very detailed, e.g. how long the time schedule in the iSFP should be or if the auditor would be allowed to ask about their personal circumstances.

b. Pilot phase: testing the product to gather feedback and improve the product

Generally, a testing or pilot phase follows the conclusion of the design phase of the concept. The scope and the duration of this phase may change: testing may be done at once, within a specific timeframe (like in Germany) or split in several steps (e.g. France). Testing can be done to gather immediate feedback from potential users, test new ideas at small scale and continuously improve the product.

In Germany, the federal iSFP was tested by 17 energy auditors from most federal states. Each of the auditors issued an iSFP for a real customer and the iSFP was evaluated based on surveys amongst the home-owners, the auditors and the software companies. The roadmap was then adapted according to the findings. Whereas the customers generally stated they were well informed and the iSFP was helpful in developing a strategy for the building, one particular area of improvement was identified: the economic assessment. The customers wanted more detailed information about each individual renovation measure.

The testing also revealed the need to offer an easily accessible training for auditors. Many mistakes and misunderstandings were made as the auditors did not always apply the detailed handbook they were provided with. The pilot also showed the need to foresee a long timeframe for software implementation, which is still in progress due to the challenges posed by the many software used for energy audits.

In France, Expérience P2E is running an 18-month testing phase, divided in three steps which feed into each other (feedback loop): the beta version of the passport was initially tested 30 times by 6 independent experts; the results were used and fed into a revised version of the tool, which was then tested 100 times by 40 selected and trained auditors (called passeporteurs – "passporters"). Both the passporters and the building owners who participated in this phase were surveyed and provided feedback about the overall experience, the process and, for the auditors only, their ability to use the tool.

The results of these surveys are currently being analysed and will be used to make additional adjustments to the tool and to design an engagement and communication strategy aiming at increasing the demand for renovation roadmaps and the number of renovations initiated. By using a feedback loop approach, the results of each phase are integrated in the following version in an attempt to continuously improve the tool, adapt it to the users' feedback and link the P2E with the introduction of a numerical logbook foreseen by the energy transition law (Figure 12).

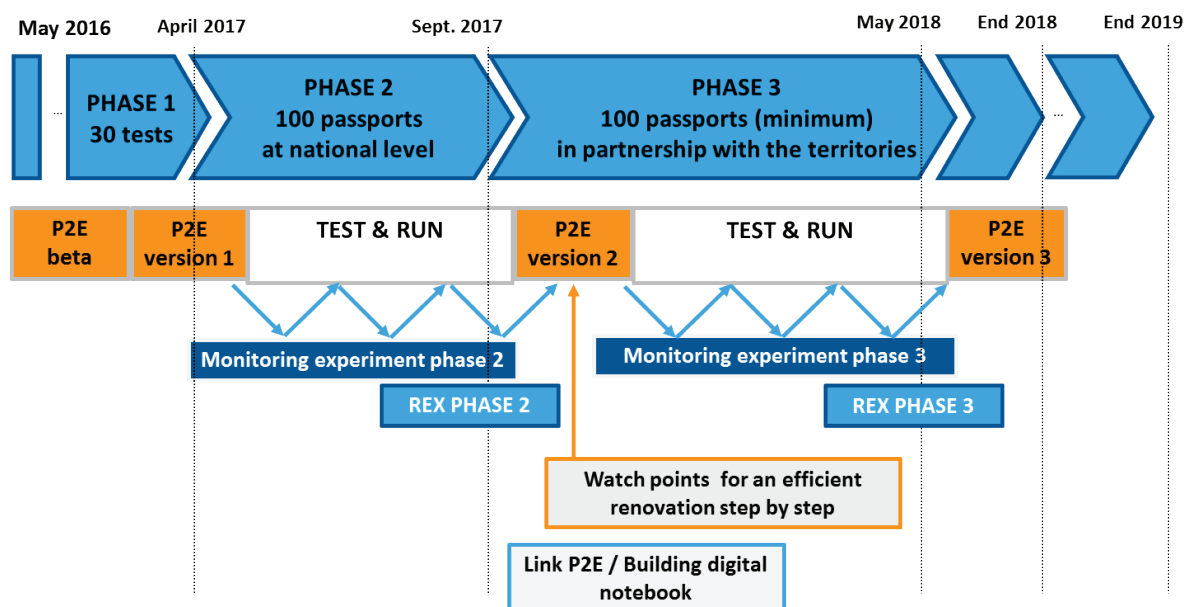

Figure 12: P2E - testing phase (Source: Expérience P2E)

IV. THE ELEMENTS OF THE BUILDING RENOVATION PASSPORT

The Building Renovation Passport is a combination of two concepts, the renovation roadmap and the logbook. The renovation roadmap delivers a long-term renovation plan for individual buildings through tailored advice to owners and investors, to contribute to the achievement of a long-term vision (e.g. each building should reach nearly-zero energy-level by 2050). The logbook is a repository of building information, going beyond energy performance, and can include features such as design plans, actual energy consumption, maintenance requirements, certificates and legal documents.

The following sections describe different approaches, with components to include in the renovation roadmap and the logbook, ownership and data gathering. All the characteristics listed are integrated in at least one of the case analysed.

i. The Renovation Roadmap

The renovation roadmap provides detailed and individualised renovation advice to building owners. The advice is based on on-site visit(s), discussion with the building owner/occupants, as well as other sources of information. In most cases (Flanders, France and Germany), the main objective for developing a renovation roadmap is to guide building owners towards deeper renovations, by providing better information about their renovation opportunities. On a societal level, the renovation roadmap can support climate and energy objectives, such as decarbonising the building stock.

To be effective and complete, an individual renovation roadmap should respect specific parameters, from ensuring the quality and reliability of the data, to establishing effective communication channels with the building owners. This section describes the key elements (see Figure 14) to consider for delivering an effective roadmap. Except for the on-site visit, which is the first step to initiate the process, the elements are not listed in order of sequence or importance.

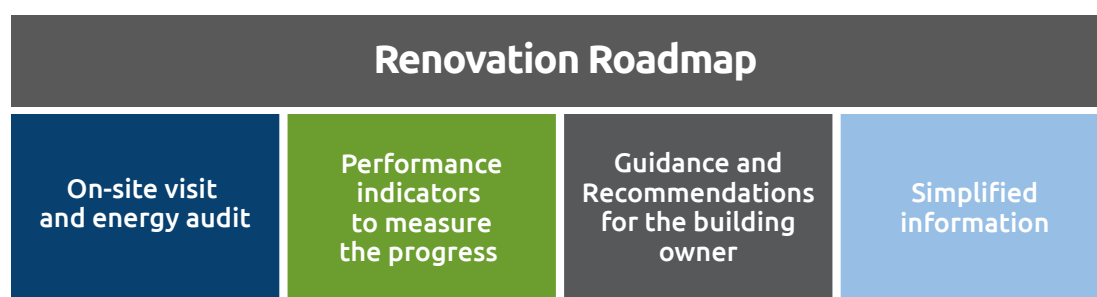

Figure 14: Key elements of a renovation roadmap

a. On-site visit and energy audit

The first step for preparing a renovation roadmap is to get to know the specific features of the building to be renovated. In most cases, this is done through an on-site visit, such as an energy audit. The on-site visit

can be an opportunity for the energy expert to retrieve essential information about the building, but also listen to the expectations, constraints and preferences of the building owner.

This initial step is a cornerstone in the preparation of the renovation roadmap in France and Germany, as well as in the BetterHome model in Denmark.

The existing cases tend to follow a similar procedure to develop the renovation roadmap; (i) first contact, (ii) on-site visit and (iii) a follow up discussion. The first contact between the energy expert and the building owner is generally a phone call. In addition to scheduling an on-site visit, the expert explains the process and purposes of the renovation roadmap, and a general discussion about the building and expectations is held. During the on-site visit, the expert inspects the status of the building and interviews (normally using a questionnaire) the occupant on preferences, ambition and constraints. All the data points are inserted into a software, from which the expert can generate a roadmap. At the follow-up meeting (phone or in person), the expert presents a number of renovation options to the building owner, and they settle on a renovation plan.

Germany: the 7-step process to develop a personalised renovation roadmap

In Germany, the building owner is put at the very centre of the process, and the individual approach, including in-depth dialogues between the building owner and the energy auditors, is considered key for the instrument. As a result, the development of a renovation roadmap includes these steps:

On-site visit

- Inspect the building and meet with the building's owner to discuss his/her wishes and needs (based on a checklist)
- Assessment of the current status of the building

Development of individual scenarios

- The auditor develops different renovation scenarios based on the result of the on-site audit. Auditor provides an overview of all the building components, prioritising what needs to be renovated
- Discussion with the owner to select his/her preferred renovation options
- The auditor provides detailed input into a software and proposes measures to implement

Presentation of results

- The results are presented to the owner during a second on-site meeting, where a decision on the final renovation options is reached (the auditor and the owner discuss the options together);
- The auditor prints the step-by-step renovation plan and delivers it to the building owner.

Figure 15: The steps from an on-site visit to a finished renovation roadmap (Source: iSFP)

France

In France, the P2E on-line platform links individuals, energy auditors and craftsmen. After a contact between the owner and the energy auditor is established through the platform, three steps will follow:

Individual contact between the auditor and the owner (30 min, by phone)

- Explanation of the approach and the procedure of the audit
- General and contextual discussion on the renovation project
- Recovery of existing elements (plans, invoices, maintenance contract ...)
- Make a quick plan of the building
- Complete the questionnaire "General characteristics"

On-site technical visit (2h/2h 30min)

- Wall inspection
- Inspection of opening elements (doors, windows, etc.)
- Floor inspection
- Roof inspection
- Systems inspection
- Evaluation of the airtightness

Dialogue (1h / 1h 30min)

Based on the technical characteristics of the buildings, the combinations available on the platform and owner's need, the auditor takes stock of the general state of the household and proposes several intervention options to the building owner. The plan presents a series of interventions to be completed by a specific date to achieve defined performance levels (compatible with the long-term energy consumption levels established by the energy transition law).

Figure 16: The steps from an on-site visit to a finished renovation roadmap (Source: Expérience P2E)

Denmark

BetterHome does not offer a long-term roadmap to its customers but provides a tailored renovation package. Different actors, banks, utilities, municipalities as well as online search engines, direct potential customers to the BetterHome website, where the customer can insert their home address and a first assessment of the building is delivered based on public data. The user can submit an expression of interest and BetterHome appoints a suitable energy expert for a visit (based on the building type, characteristics and potential measures highlighted by the building owner). The image below describes (Figure 17) a simplified version of the energy expert's dialogue guidelines for the first steps of the process, from the initial contact to a signed contract.

Individual contact between the installer and the owner (phone)

- The owner indicates his/her interest through the online platform
- The installer starts a new process in the online application
- Discussing preferences, expectations and potential measures
- Arranging a time for the on-site visit

On-site visit

- Deep discussion on potential improvements
- Setting out timeframe and financial boundaries for the project
- Questionnaire on comfort (IAQ, lightning , temperature etc.)
- Questionnaire on building characteristics (performance, heating system, heating source, etc.)
- Present the calculation from the digital platform (based on questionnaires) on energy saving potential and indoor air quality

Proposal development

Check the proposal so that its measures meet the expectations of the building owner

Figure 17: The steps from an on-site visit to a finished renovation roadmap (Source: BPIE)

Training of auditors

Constructing a renovation roadmap might require additional abilities or perspectives from the energy expert. The difference from issuing an EPC or conducting an energy audit is the long-term perspective of the building (up to 10-20 years). The energy expert should be able to explain the different steps in a long-term step-by-step renovation process. A proper training of the energy expert is essential for the success of the Building Renovation Passport: auditors often follow specific routines and while they usually have an excellent technical knowledge, their ability to clearly communicate with their clients is a weak spot. The Building Renovation Passport requires a bigger effort from the energy expert, which could be eased through better supporting tools (checklists, online platforms, etc.).

In Denmark (BetterHome) and in Germany (iSFP), the specific routines, habits and short-term vision (short-term renovation plan) of the energy experts and auditors were an obstacle, which could result in a lack of interest on the Building Renovation Passport (lack of demand), the absence of a follow-up (i.e. no renovation) or in unsatisfactory results (just a shallow renovation).

To overcome this barrier, the energy experts must be trained to use the new tool and deliver long-term renovation advice.

BetterHome: the sales pitch

BetterHome recognises that to increase investments in energy renovations, the sales pitch must be tuned beyond energy savings and returns on investment, and focus on indoor comfort and air quality as well. For this reason, part of the installers' training focuses on how to address potential customers and get them to realise the full value of the energy renovation.

In addition, the full process is designed to incentivise the energy auditor: an online application minimises the extra work for the energy auditor, and from the first contact with the home-owner to the finalisation of the project every step is clearly outlined. The auditor, who is also often an installer, fills in a simple checklist on the state of the building (the information is fed into the online application to calculate energy savings and indoor air improvement based on different packages of measures) and can then easily extract a renovation proposal for the building owner based on the information gathered on-site. In short, the digital solution creates a leaner process for the building professionals, enabling a better renovation service for the owner.

iSFP: the checklist

In Germany, training also includes communication skills and the life-cycle approach of building elements. The auditors are supplied with an extensive manual and checklist (see Figure 18) to be used in preparation of the on-site visit and for the creation of the individual renovation roadmap.

Teil A: Eigentümer- & Nutzerangaben

Gebäudeeigentümer

Name Gebäudeeigentümer _____

Strasse, Hausnummer _____

PLZ, Ort _____

Telefonnummer, E-Mail _____

Allgemeine Nutzungsdaten

Anzahl der Bewohner: _____ Tägl. Anwesenheit: _____ Stunden (ca) Familie mit Kindern Alter der Kinder: _____

Energetische Maßnahmen am/Im Gebäude

Welche energetische Sanierungsmaßnahmen sind in den letzten Jahren durchgeführt worden?

Bauzeile:	Jahr:	Angaben zu durchgeführten Maßnahmen (Dämmstärke, Material, WLS, Effizienz Heizungstechnik)
<input type="checkbox"/> Dach / oberste Geschosdecke	_____	_____
<input type="checkbox"/> Fassade / Außenwand	_____	_____
<input type="checkbox"/> Fenster	_____	_____
<input type="checkbox"/> Rollläden	_____	_____
<input type="checkbox"/> Kellertür	_____	_____
<input type="checkbox"/> Kälteboden/ Bodenplatte	_____	_____
<input type="checkbox"/> Kältetechnik (Heizung/Warmwasser)	_____	_____
<input type="checkbox"/> Sonstiges	_____	_____

Welche baulichen und gestalterischen Maßnahmen sind in den nächsten Jahren geplant?

Maßnahme:	Umsetzungstermin:
<input type="checkbox"/> Instandsetzungen:	_____
<input type="checkbox"/> Modernisierung:	_____
<input type="checkbox"/> Umbau / Erweiterung:	_____
<input type="checkbox"/> Allergiereduzierendes:	_____
<input type="checkbox"/> Bad- / WC-Anbau:	_____
<input type="checkbox"/> Nutzungsänderung:	_____

zur Verfügung stehender / geplantes Budget in EUR _____

Sollten bei den Modernisierungsentscheidungen Förderbedingungen berücksichtigt werden?

Ja, welche _____ Nein

Wurde bereits die Luftdichtheit des Gebäudes gemessen?

Ja Ergebnis der Messung: _____ Nein

Wurde bereits eine Gebäudethermografie durchgeführt?

Ja Auffälligkeiten: _____ Nein

Obt es bereits eine Bauphysikanalyse?

Ja Nein

Integration von Smart-Home-Elementen

Vorhanden Geplant _____

Figure 18: First section of the iSFP checklist (Source: BMWi)

Who pays the auditor for the individual renovation roadmap?

Delivering a renovation roadmap has a cost, mostly in terms of labour costs (auditor's on-site visit and time needed to input data and produce the renovation roadmap).

Depending on the business model, these costs could be covered by different players: by the building owner by paying a fee for the on-site visit, through the repayment of an energy efficiency loan/mortgage, or they could be covered or subsidised by the entity which offers the service (e.g. a public authority or a private company).

In Germany, a subsidy is available for the iSFP, run by the federal Office for Economic Affairs and Export Control (BAFA), under the “Energieberatung vor Ort” programme. This programme grants subsidies of up to 60% for an on-site audit (maximum 800€ in single and two-family buildings, 1100€ up from three dwellings).²⁵

In Denmark, the on-site visit is offered free of charge to the customers as it is assumed that the potential investment in renovating the building will cover this expense.

In France, for the time being, the on-site visit is also free of charge, but different options are being considered for the future (including introducing a fee of maximum 400€ - or recovering costs via financing programmes). Should a fee be introduced, exceptions for low-income households or other categories may be needed to avoid an “access barrier”.

b. Measure progress with a selection of performance indicators

A performance indicator is a measurable value that demonstrates how effectively a certain objective is being achieved. A renovation roadmap can focus primarily on the building’s energy performance characteristics or fit into a wider focus that also incorporates health, comfort and behavioural aspects.

The first step towards developing a renovation roadmap is to understand the building conditions (what is the current situation?). This requires an on-site visit by a building professional (see section above) or another method to collect the required information remotely.

The second step is to answer the question, what is the objective of this exercise? Both personal (what does the owner want) and policy objectives (e.g. reaching nZEB or BBC levels) must be considered. To facilitate this task, in Denmark and Germany, energy auditors are equipped with a checklist of essential information to be included and registered during the visit.

The final step is to answer the question, what do we have to measure to effectively be able to implement and monitor the performance improvement? A list of potential key performance indicators is provided below (Figure 19). Other indicators can be added to this list, based on specific local or market conditions and requirements. A modular approach (core indicators + additions) would allow to adjust and familiarise with the essential parts of the renovation roadmap (e.g. thermal comfort) before developing or adding new features (e.g. smart components). Annex B provides a list of indicators used in Flanders and France.

25. http://www.bafa.de/SharedDocs/Kurzmeldungen/DE/Energie/Vor_Ort_Beratung/20170512_sanierungsfahrplan.html



Figure 19: List of the main potential indicators to be included in a renovation roadmap

c. Guidance and recommendations

Lack of awareness of which measure to implement and in which order is one of the main barriers to deep energy renovations. Transforming a normal building to a highly-efficient building is a complex process that requires the right expertise. Providing guidance to the user is a central part of the renovation roadmap. The recommendations include specifics on the type of measures required and in which order they should be implemented. Recommendations can also be linked to information about available financing instruments, like financial subsidies and tax exemptions. The roadmap could also include guidance to the occupants on how to adapt their behaviour to the upgraded building (e.g. how do you optimise the energy savings from the new thermostat).

26. Use of 7-point scale ranging from cold (-3) to hot (+3) (Cold - extremely uncomfortable, Cool - uncomfortable, Slightly cool - slightly uncomfortable, Neutral - Comfortable, Slightly warm - slightly uncomfortable, Warm - uncomfortable, Hot - extremely uncomfortable)

27. Measurement of thermal comfort parameters to estimate indexes of: Predicted Percentage of Dissatisfied (PPD) and Predicted Mean Vote (PMV) indexes (ISO 7730)

Linking individual recommendations to the long-term goals

In Flanders, the EPC+ is an enhanced version of the Energy Performance Certificate, aiming not only at informing potential building buyers of the energy performance of a property, but at providing them with a very clear picture of what is needed to achieve a future-proof energy-efficient standard (E60 by 2050 = a primary energy consumption of 100 kWh/m²/year). The potential buyers will be informed about the investments required in the future for the building.

The renovation advice includes recommendations for various measures - beyond energy - that accompany a thorough renovation (e.g. airtightness, ventilation, etc.)

Overzicht aanbevelingen







		HUIDIGE SITUATIE	AANBEVELING	PRIJSSCHATTING	LABEL NA RENOVATIE
1		Ramen Er is momenteel nog overal enkele beglazing aanwezig	Plaats nieuw schrijnwerk met hoogrendements beglazing	€ 8000 - € 12 000	D
		Verwarming Ketel is sterk verouderd en niet energiezuinig.	Plaats een efficiënt verwarmingssysteem	€ 4500 - € 6500	D
2		Muur De muur is niet geïsoleerd voor een gedeelte van 147m ²	Plaats isolatie	€ 13 500 - € 15 000	B
		Hellend dak Het dak is beperkt geïsoleerd.	Plaats bijkomende isolatie	€ 12 000 - € 16 000	B
3		Hernieuwbare energie Er is geen hernieuwbare energie aanwezig	Overweeg plaatsing hernieuwbare energie	€ 7500 - € 10 000	A
4		Muur De muur is geïsoleerd (voor een gedeelte van 63m ²), maar er is niet voldoende isolatie aanwezig om de lange termijn doelstelling te halen.	Overweeg bijkomende isolatie op het moment dat deze muur gerenoveerd wordt.		A
1	Prioriteit 1 Niet goed, zo snel mogelijk te renoveren.		2	Prioriteit 2 Te renoveren.	
			3	Prioriteit 3 Interessant te overwegen.	
			4	Prioriteit 4 Redelijk goed, puur energetische renovatie, niet aangegeven.	

Figure 20: Example of renovation recommendations according priorities in Flemish EPC+ for windows, heating, walls, roof and renewable energy (Source: Flemish Energy Agency)

The information is provided by an energy expert and includes an estimation of the investment cost (as illustrated in Figure 20).

In Germany, the iSPF offers tailored recommendations ensuring a cost-effective long-term renovation path. In contrast to the Flemish EPC+, there is not a set energy target for all the building stock, but a specific target is set for each building based on the buildings capability to reduce energy. In addition to a step-by-step roadmap (see Figure 21), the iSPF includes information on what the potential measure will bring (e.g. warmer feet and lower heating costs), investment costs and potential subsidies, energy savings and clarifications on why these measures are needed.



Figure 21: Overview of long-term transition in the German iSPF (Source: BMWi)

What is included in the recommendations?

The renovation roadmap should include:

- a clear overview of the proposed measures and the expected improvements after renovation in comparison to the starting point, and
- a detailed description of the suggested measures to help the building owner fully understand the renovation plan and its benefits.

One of the objectives of the renovation roadmap is to provide the user with straightforward information about the status of the building and how the renovation will impact the building performance, energy bills, comfort and wellbeing. The first page of the renovation roadmap should include a simple illustration of the building. An effective illustration could convince the user to start the renovation journey and keep on upgrading the building.

Figure 22 is an illustration from the German iSPF showing the status of eight central building elements: walls, roof, ventilation, windows, domestic hot water, floor, heating and heat distribution. The simple colour scale makes the graphic very easy to understand.



Figure 22: Overview of the building's condition and renovation needs (Source: BMWi)

The first page of the Flemish EPC+ also displays a very simple energy performance scale, aligned with the classification of the Flemish EPC and shows the potential energy savings of three step-by-step renovation packages (see Figure 4).

The BetterHome model uses very simple information to convince building owners to invest in deep energy renovations by showing a first estimation of the amount of energy the building is wasting.

Details could include several elements, like the starting point (current building status), the foreseen results after the implementation, including comfort, cost of the measure, energy savings, link with available financing instruments, CO₂ reductions, etc. (see Figure 23 for

an example from the German iSPF). The German iSPF deals with comfort differently than it does for other performance indicators, since the roadmap does not include any formal comfort indicator, like noise or indoor air quality. Instead, comfort levels are measured in a qualitative way, based on the professional judgement of the auditor. Comfort is expressed in a separate box with a description of the expected benefits that the building occupant will gain after the renovation, for instance “warmer feet” or “better light”. The renovation roadmap also includes a page on how to save energy in the use-phase and by changing behaviour.



Figure 23: Example of recommendation in German iSFP (Source: BMWi)

d. Data gathering

On-site data gathering is the first source of information for the renovation roadmap. To generate a successful process for data gathering, some key aspects should be considered: make the tool simple for the auditor, generate value for the building owner and use the data in a smart way. Key success factors are listed below:

- **Checklist:** The German iSFP, P2E and the Danish BetterHome model supply their energy experts with comprehensive checklists of how to conduct the on-site visit, what information to collect and what to ask the building owner. The expert fills in simple checklists on the state of the building, the information is fed into the online application to calculate energy savings and indoor air improvement depending on different packages of measures. Furthermore, the installer can easily extract a renovation proposal for the building owner based on the information gathered.
- **Automation:** To reduce costs, the Flemish Energy Agency (VEA) is developing a user-friendly tool for the energy expert. The tool is based on the input data itself and proposes standard advice. It works with prefabricated text blocks as much as possible. In the prefabricated blocks of text, specific property parameters will be included so that the advice is personal. A similar method is used by BetterHome in Denmark.
- **Online application:** BetterHome provides an online application that helps minimise extra work for the energy experts. Every step is clearly outlined, from the first contact with the home-owner to the finalisation of the project.

- **Relationship building:** The iSFP and BetterHome consider the energy audit as a great opportunity to build a professional relationship with the building owner. The energy auditor is seen less as an inspector and more as an advisor. A better relationship between the owner and the auditor can increase trust and awareness and also enrich the renovation roadmap (and eventually the logbook) with more accurate information.

Different ways of retrieving information are discussed by the different organisations. Flanders is developing its instrument (the Woningpas) to allow for other types of information gathering (e.g. by the building owner directly or from the utilities). Data processing can change according to each model (e.g. by using a dedicated software or by adapting the existing energy audit software).

The BetterHome model is currently developing a mobile application for the building owner. This can be used for a two-way communication, where the building owner can obtain support and BetterHome can nudge them to use their energy more wisely. In addition, the application will automatically notify the building owner when it is time to consider investing in a new measure (e.g. change heating system).

ii. Logbook

In addition to the renovation roadmap, the Building Renovation Passport includes a logbook, i.e. a storage space where the building's features and information (e.g. stability, durability, water, installations, humidity, maintenance requirement, etc.) can be collected and regularly updated. The logbook is a repository of information and data related to a specific building, including energy bills, equipment maintenance recommendations as well as insurance and property obligations and financing options available in the area for renovation projects (e.g. green loans, incentives, tax credits). Ideally, this information is inventoried in a digital register, belonging to the property owner, who is also the main user of the logbook. Depending on its intended use, owners could grant access to some information to public authorities (e.g. municipality, property tax office), building professionals and craftsmen, and make some information publicly available, while keeping other data private or restricted (semi-public upon authorisation to third-parties). This section describes three key elements of the logbook: functionalities, data gathering and ownership.



Figure 24: The key elements of the logbook

Most of the description of the components of a logbook is based on the Flemish case. Out of the four cases, Flanders is the only one to have developed a logbook (the Woningpas) as integral part of the Building Renovation Passport.

In France, the energy transition law²⁸ foresees the creation of a logbook (Carnet numérique de suivi et d'entretien du logement). P2E is participating in the pilot phase, together with several market actors (11 teams, including 3 big data companies). Beyond defining which data entry should be included in the logbook, key issues like consumer privacy and protection, data accessibility and security will also be analysed²⁹. The Danish BetterHome and the German iSFP do not include a logbook in their model at this stage.

a. Functionalities

The logbook functionalities are developed based on the core elements and information it should provide. In Flanders, the Woningpas allows the user to use different services according to specific preferences. The portal is centred on different blocks, where *energy* constitutes one block (see Figure 25). VEA worked out a business analysis for the Woningpas together with a private consultant, in which their requirements were mapped and blocks were shaped. To find out what services may be provided by the Woningpas, consultations were also held with other government agencies managing buildings data (Flemish Region, Federal Government and Municipalities) and with distribution operators.



Figure 25: Building blocks of the Woningpas
(Source: Flemish Energy Agency)

Over time, different modules that define the property and the quality of living will be added to the Woningpas. The instrument forms a dynamic, modular interface, where various aspects are interlinked and reinforce each other.

The energy module (or block) was the first to be developed. It provides information about the energy performance of the building and its energy-saving potential, allows the building owner to update and follow-up the energy performance progress. The energy module can be linked with other aspects of the Woningpas, such as stability, acoustics, accessibility, water, building physical aspects including moisture, spatial planning, presence of utilities and installations, hazardous substances (such as asbestos) and renewable energy.

In Germany, several online tools offer similar functionalities to the logbook, but none provide the same holistic view on the building. The examples below are all active on the German market, similar tools may also be available in other EU countries:

28. Loi n° 2015-992 du 17 août 2015 relative à la transition énergétique pour la croissance verte

29. The debate about the building logbook in France is part of a larger debate about 'digital identity', about how distinct types of data linked to each individual (health, banking info, home data, etc.) could be included in a 'digital safe' (coffre-fort numérique) to be managed and protected digitally to guarantee data security and consumers protection.

- CO2online (www.co2online.de) offers a number of consulting tools for building owners, such as a heating system analysis calculated from the measured consumption and an analysis of the energy consumption over long time periods.
- The federal Ministry of Economics and Energy offers the Sanierungskonfigurator (in English renovation configurator - www.sanierungskonfigurator.de). The tool allows the user to edit the current state of his building and calculate the cost and benefits for various renovation measures. It is not very user-friendly as it requires a deeper technical understanding. A second tool with similar functions is "Sanierungsrechner"³⁰, run by the company Bosch.
- The tool Eigenheim-Manager (<https://eigenheim-manager.de/>) is designed as a central building information platform. Owners can store buildings' documents (contracts, insurance policies), edit their energy consumption into an app to get an analysis (and therefore lower energy costs) by showing individualised alternative suppliers. It also offers a reminder function for recurring maintenance tasks and thus provides a certain quality management.

b. Data gathering

According to VEA, the credibility of the Woningpas depends on the reliability of the data. Linking the Woningpas to authentic building data sources managed by the government (for example, certificates and inspections) or other sources can increase trustworthiness. On the other hand, many relevant documents are not managed by a public authority and are only available on paper (e.g. invoices of maintenance, technical information of HVAC systems).

Mapping the data sources is essential to know what can be offered through the logbook.

The steps taken by VEA to identify potential sources and indicators are listed below:

1. Identify potential data that can be integrated in an exchange service between the source (e.g. governmental agency) and the platform (i.e. Woningpas);
2. Identify publicly-available data;
3. Identify which data users find most interesting (using prototype testing):
 - a. The result of the testing showed that most of the time the users did not understand the proposed indicators. The users did not show a preference for specific data, but favoured a given interpretation (e.g. good, not good, excellent).
 - b. The indicators for energy are provided by the existing indicators used in the Flemish building code and EPC, but they had to be translated into a value (not good at all, not good, good, very good, excellent). Sometimes the data was shown (E-level, primary energy consumption, insulation level) by its numerical value as they were considered to be known to the users. Sometimes they had to be translated to increase the users' understanding (CO₂-emissions for example). Without the ability to relate the amount to a scale (good – bad) or to an issue the user is more aware of (e.g. the emission equals five transcontinental flights), it can be hard to grasp what a number represents.
 - c. The testing also showed what data users would like to see but which are currently missing.

30. <https://application.effizienzhaus-online.de/sanierungsrechner/#?state=0>

c. Ownership and data-privacy

The logbook is a storage space where the building's features and information can be collected and regularly updated. In most cases, the information gathered in the logbook will hold some details that the owner may want to keep private.

Data privacy and security are protected by the EU legislation (the new General Data Protection Regulation will enter into force in 2018) and every development regarding adding confidential information to a digital document will have to respect this regulation. At the same time, the logbook ought to be enriched with enough information to become useful. Every country/region will have to find a balance between effectiveness and privacy. While new advancements in technologies should be pursued to increase both, the Flemish Woningpas and the German iSFP (roadmap – as the logbook doesn't exist in Germany) adopt very different approaches regarding ownership and security.

- In Flanders, building owners will have access to the Woningpas (see Figure 26) through their electronic ID card and will have the opportunity to authorise access to public authorities and other actors, such as buyers, tenants, architect, experts, contractors, lawyers and real-estate agents. For future developments, the use of blockchain technology³¹ is also being considered to facilitate a smooth and safe exchange of information. The building owner can, and is encouraged to, increase the amount of data available on the Woningpas by uploading supporting documents. For example, after an investment in the building, the owner may decide to update the energy performance based on evidence and information on the performance of the installed equipment or installations. By doing so, it is possible to monitor the progress towards the long-term target. In later versions of the Woningpas, it will also be possible for construction partners (architect, energy expert, installer, contractor) to contribute to the technical file with additional information (once accepted by the owner).

31. Blockchain is a special digital technology for peer-to-peer transaction platforms that uses decentralised storage to record all transaction data. Blockchain enables "smart contracts", which can, for example, enable households that not only consume but also produce energy, to buy and sell energy directly, in a simple and secure manner.

Figure 26: Excerpt from the Woningpas (Source: Flemish Energy Agency)

- The iSFP will be handed to the building owner in a printed version. While the printed model (almost) fully guarantees privacy of the building-related data, the digital model is more flexible, enabling the roadmap and logbook to be easily updated and revised. If the building owner sells the estate, there is no automatic procedure to hand over the roadmap to the buyer, nor is there any right to request this document. The iSFP is owned solely by the building owner, meaning that no commercial activities can be linked with the roadmap.

The different instruments have a few things in common: the output is owned by the building owner, they are user-centric and they bring added value to the end-user. In Germany, the building owner is central in developing the roadmap, leading to a sense of ownership which will increase the possibility that the owner will follow the steps outlined in the roadmap. In Flanders, the logbook is meant to bring added value to the building owner by facilitating administrative simplification and an easier management of building information. This should motivate the building owner to use the tool and regularly update information.

V. LESSONS LEARNT

The overview of the processes behind the creation of an Individual Building Renovation Roadmap in the four real-life examples presented above offers valuable lessons about the route that leads to a successful development and implementation. Regardless of the nature of the originator (private, public or a combination of both) or its geographical coverage (municipal, regional or national), creating the conditions for a successful implementation of a Building Renovation Passport requires careful planning. The process can be summarised in four main blocks (see Figure 27): exploration, concept design, implementation and evaluation.

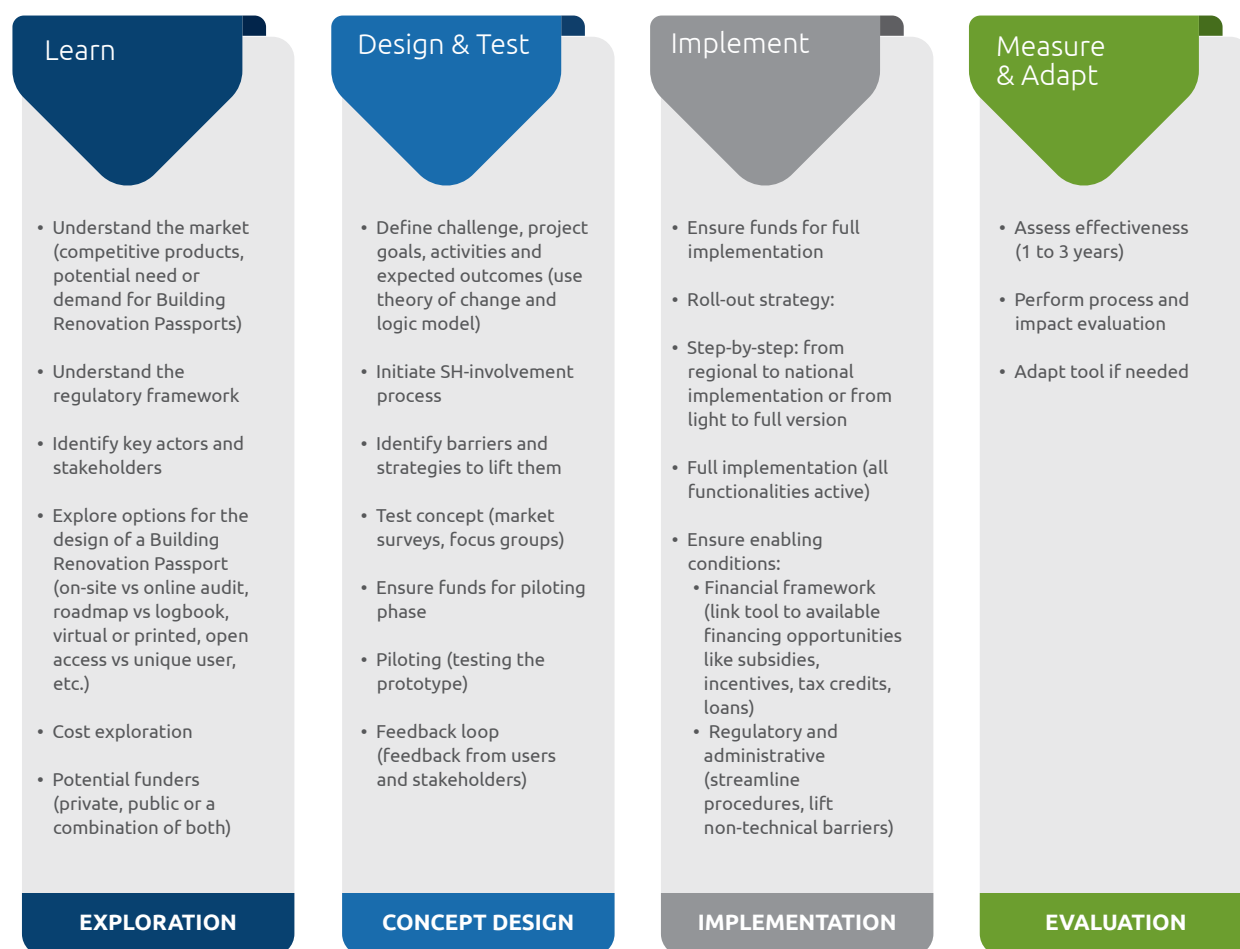

Figure 27: Process flow of the creation of an Individual Building Renovation Roadmap

In the **exploration phase**, it is important to get familiar with the landscape (the legislative framework, the renovation rate, innovation in the construction sector, the quality and awareness of energy auditing, etc.) and identify the key market players and stakeholders to involve in the project. The results of this phase can be used to refine the initial idea and the internal process (**concept design**) to define the problem to solve,

project goals, activities and expected outcomes, barriers and the target audience (who will use the final product). This phase may require the support of logic models and theory of change, market analysis and surveys to clearly define the overall project objectives and potential activities.

Concept design also includes piloting and testing. The duration of the testing phase may vary from a few weeks to several months and can be done in small (a few dozen tests) or large scale (a few hundred). Testing should be used to get feedback from the potential users (e.g. building owners, auditors, public administrations, craftsmen and installers) to report bugs, errors, practical use (e.g. paper vs. online) to drive the refinement of the tool through a series of iterations and upgrades.

The complexity of this phase depends on many factors and local conditions, including the number and nature of stakeholders to involve, the technical, legislative, regulatory or financial barriers and the scale of the pilot phase.

After design and testing are completed, the tool is defined and ready to be put on the market (**implementation**). The implementation could be done step-by-step (from local to national level or by introducing a lighter version of the Building Renovation Passport, followed by a complete version later) or in one-go. During the implementation, the enabling conditions for the successful use of the Building Renovation Passports are also put to test: the availability and access to financial instruments (access to financing opportunities), the regulatory and administrative framework (how easily can I get access to a Building Renovation Passport? How easily can I get permission to renovate?) and the usability of the tool (can the user understand it? Can he/she get all the information needed to start a renovation project?).

An **evaluation** should be performed after the tool has been available on the market for one year (and 2-3 years that) to assess and measure the success of the tool, based on the conditions and objectives set in the concept design phase. Performance indicators, analytics and users' feedback can be used to adapt and evolve the tool to ensure its usability and added value over time.

i. Key success factors

Despite an encouraging start, it is still too soon to assess whether the four examples presented in this report will be fully successful. However, the research conducted so far and the feedback gathered directly from the initiators of the individual renovation roadmaps has helped identify potential 'rookie mistakes and pitfalls' that should be avoided when developing a building renovation roadmap:

- **Get the right people around the table:** stakeholder engagement is a key step in the process, but it is extremely important to engage with the right stakeholders and avoid involving people who cannot add value to or even hamper the discussion (or exclude some that could greatly contribute). For this reason, the mapping exercise in the exploration phase is crucial: one needs to know from the very beginning what are the potential allies and the enemies with whom it's important to engage over the entire

duration of the project (e.g. potential data providers, investors, consumers' groups, notaries, social housing groups, realtors, utilities and building valuers, etc.)

- **Beware of timing:** ensure the proper timing of each phase of the process to avoid a stop & go approach. For example, it may not be wise to pitch the project to an outgoing administration (e.g. 12 months before elections) or CEO, since the new people occupying decision-making positions may have different priorities and interests. Also, if the time between concept design and implementation is too long, competitors could enter the market first.
- **Show me the money:** ringfencing funds to complete the process from exploration to evaluation should be a priority. Failing to do so may jeopardise the ability to test and implement the Building Renovation Passport. Having funds guaranteed for a few years may also help in case of a change of management and prevent the dismissal of a project if political priorities change (see above). Looking for investors, especially in the private sector, is also an opportunity to test the project idea and get feedback early-on.
- **Go beyond energy:** one of the added values of the individual building renovation roadmap is its holistic approach to building renovation. Both the renovation roadmap and the logbook should go beyond energy and provide useful information about the building and all its components (structure, hazardous material, air quality and comfort, equipment maintenance and replacement, administrative requirements). This is one of the reasons why it is important to invite non-energy experts into the process from an early stage.
- **Ensure usability and affordability:** the individual building renovation roadmap is made for its users and must be easy to use and affordable. The project team should include various profiles, not only energy or technical experts. Involving users in the design phase will help keep focus on this and avoid designing a byzantine tool that may be too difficult to use. Testing should be rigorous and users' feedback should be fed back into the design process.
- **Create demand:** even the best products won't be sold unless consumers ask for it. Promoting the Building Renovation Passport concept through the proper channels and in a language that the end-users (residential building owners) can fully understand is as important as developing a good product. While the individual building renovation roadmap is a response to a specific market barrier (the uncertainty and lack of knowledge about how to start the renovation process and what to do), the demand for this service is still limited. Demand can be driven by three factors:
 - **Creating a need:** by linking the Building Renovation Passport to the approval for a renovation loan or including it among the eligibility criteria for accessing energy efficiency financing.
 - **Creating a desire for a new service:** organise a marketing and communication campaign targeting building owners offering trustful and understandable advice and information to home-owners about how they can renovate their property.
 - **Creating an obligation:** the Building Renovation Passport becomes mandatory (i.e. through a regulatory requirement, like building transactions, change of use, extension, etc.). It is worth noting that like for the EPCs, creating an obligation, if not matched with a quality control mechanism and a good communication campaign, is not a guarantee for success.

VI. REFERENCES

1. BPIE, "97% of buildings in the EU need to be upgraded," 2017.
2. EU Commission, "EU Building Stock Observatory," 2017. [Online]. Available: <https://ec.europa.eu/energy/en/eu-buildings-database>. [Accessed 29 10 2017].
3. European Commission, "COMMISSION STAFF WORKING DOCUMENT - IMPACT ASSESSMENT - Proposal for a Directive of the European Parliament and of the Council amending Directive 2010/31/EU on the energy performance of buildings," no. {SWD(2016) 415 final, 2016.
4. BPIE, "Renovation strategies," 2016.
5. BPIE, "Renovating Romania," no. Available: http://bpie.eu/wp-content/uploads/2015/10/Renovating-Romania_EN-final.pdf, 2014.
6. Eurostat, "Population change," [demo-gind], 2017.
7. BPIE, "Financing the Future of Buildings Central, Eastern and South-East Europe," no. Available: http://bpie.eu/wp-content/uploads/2017/09/MAPPING-FINANCIAL-STREAMS_FINAL_LR.pdf, 2017.
8. EU Commission, "Energy efficiency in public and residential buildings - Final Report Work Package 8 - Evaluation of Cohesion Policy programmes 2007-2013. Annex 2," 2015.
9. Qualicheck, "Romania| Assessment of Quality and Compliance in the Certification of Energy Performance of Buildings," 2016.
10. BPIE, "BPIE Survey 2014".
11. IBROAD, "Survey 2017".
12. Romanian Energy Regulatory Authority - Energy Efficiency Department, "Energy Efficiency trends and policies in Romania," September, 2015.
13. L. B. M. A. P. S. J. Sousa, "Research on the Portuguese Building Stock and its Impacts on Energy Consumption – an Average U-Value Approach," Archives of Civil Engineering, Lix, 4,, pp. 523-546, 2013.
14. Eurostat, "Inability to keep home adequately warm - EU-SILC survey," [Online]. Available: http://appsso.eurostat.ec.europa.eu/nui/show.do?dataset=ilc_mdcs01&lang=en.
15. Concerted Action - Energy Performance of Buildings, "Implementation of the EPBD," 2015.
16. ADENE, [Online]. Available: http://www.adene.pt/sce/micro/peritos-qualificados?page=80&habitacao%5Bsem%5D=sem®iao=All&concelho=all&distrito=all&perito=&nome_completo=&op=Search&form_build_id=form-YxN_wW8WnTqZz4mK1H1470M0BSYcjxgLLVeiTwzwe&form_id=peritos_webservice_form. [Accessed 2017].
17. BPIE, "Energy Performance Certificate across the EU," 2014.
18. IEA, "Glossary," [Online].
19. ifeu, DENA and Passivhaus Institut, "Der individuelle Sanierungsfahrplan - Methodik und Praxis," 2016.
20. VEA, "Renovation advice (Summary Concept)," 2016.
21. VEA, "Digital Building Passport (Summary Concept)," 2016.

22. The Shift Project, "Passeport Rénovation Energétique. Résultats préliminaires du groupe de travail," 2014.
23. The Shift Project, "Rénovation thermique des bâtiments. Résumé aux décideurs," 2013.
24. The Shift Project, "The French Passeport Efficacité Energétique (PowerPoint presentation)," 2015.
25. Ministerium für Umwelt, Klima und Energiewirtschaft Baden-Württemberg, "Sanierungsfahrplan".
26. T. W. NAPE, "The Impact of Energy Performance Certificates on property values and nearly Zero-Energy Buildings (ZEBRA2020 project)," 2016.
27. BPIE, "Boosting building renovation: an overview of good practices," 2003.
28. T. S. Project, "Performance Energétique du Bâtiment - Programme de rénovation thermique du parc existant," 2013.
29. ENTRANZE, "Report on specific features of public and social acceptance and perception of nearly zero-energy buildings and renewable heating and cooling in Europe with a specific focus on the target countries," 2014.
30. Velux, "Healthy Home Barometer," 2016.
31. European Commission, "Commission welcomes agreement on energy performance of buildings," 2012. [Online]. Available: <https://ec.europa.eu/energy/en/news/commission-welcomes-agreement-energy-performance-buildings>.

VII. ANNEX A: DEFINITIONS

i. General definition of deep (staged) renovation

There are several ways to define deep renovation, step-by-step renovation and deep-staged renovation. In absence of a common definition of each of these three concepts, below we provide an overview of the terminology as currently used by different building experts, including BPIE.

Step-by-step renovation roadmap (or staged renovation)

A renovation plan with a horizon of up to 15-20 years that, by looking at the building as a whole, suggests the installation of selected measures in a certain order to avoid that at any stage of the renovation the installation of additional measures is precluded.

Depth of renovation

There is no common definition for “deep renovation”, “staged renovation” and “deep-staged renovation”. As demonstrated in this report, each of the examples analysed uses a different definition of what a deep renovation is.

There are, however, common features among all initiatives, like the will to raise the level of ambition for achieved energy performance, to ensure consistency between short and long-term measures and to align the target for the performance of individual buildings with the long-term target for the entire building stock.

ii. Flanders

Deep renovation

VEA does not use a definition for deep renovation, but refers to a long-term efficiency objective: existing buildings must achieve the E60³² level by 2050. This corresponds to 100 kWh/m² gross surface, combined with a series of mandatory requirements (measures and installations). Users can choose how to combine these elements based on their individual needs. The long-term efficiency objective is currently a voluntary target, but VEA is exploring the possibility to make it mandatory in the future.

VEA considers this long-term goal “a pragmatic objective”³³ that seems feasible for both the citizens and the construction industry. However, this objective will be evaluated regularly and, if necessary, tightened in order to meet the commitments on energy-efficiency improvements and CO₂ reductions.

32. New buildings today must achieve an efficiency level of E60, while nZEB level is defined as E30.

33. Interview on July 18, 2016.

iii. France

Deep renovation

The definition of deep renovation used by P2E is the following: a deep renovation is the renovation of a given dwelling reaching high level of efficiency in one go (global renovation) - the objective is to achieve a BBC level of renovation, equivalent to 80kWh/m² of primary energy per year, including heating, hot water and cooling.

Staged-deep renovation

Staged-deep renovation has the same efficiency target as deep renovation, but renovation can be paced out over a longer time-horizon. According to P2E, this approach has the advantage to limit upfront costs and allows building owners to plan their renovation over time. On the other hand, the risk of lock-in effects and consequent lower comfort-improvement is higher.

iv. Germany

Deep renovation

iSFP is not “defining” deep renovation, but introduced the “best possible principle”, replacing the concept. According to this principle, the efficiency level that the building stock has to reach on average is equivalent to the KfW’s Efficiency House 55³⁴ (corresponding to about 30-40 kWh/m²/a of primary energy consumption for a single family house).

As a general rule, the auditor has to recommend the most ambitious standards and options for each component of a particular building. If this is not possible, he/she has to explain why they advise the owner to deviate from the best possible standard.

The building modelling used for the iSFP can simulate the impact of each renovation on the overall energy efficiency target, allowing it to monitor if too many buildings deviate from the best possible standard, which could result in the target being missed.

34. In Germany, energy efficiency standards for new buildings are laid out in the German Energy Conservation Ordinance *Energiesparverordnung* (EnEV). KfW (Kreditanstalt für Wiederaufbau), Germany’s development bank, has developed a financing mechanism for the refurbishment of existing residential building based on these standards. Efficiency House 55 indicates the percentage of the EnEV’s primary energy requirements for new buildings that an existing building has to meet after renovation.

VIII. ANNEX B: PERFORMANCE INDICATORS FOR THE RENOVATION ROADMAP

The long-term transformation of an individual building, as well as the whole building stock, requires a number of measurable variables and performance indicators. A general list of indicators is presented in chapter IV.

i. Flanders - EPC+

The EPC+ includes recommendations, (ordered from high to low priority) and points of attention (no priority). The recommendations and points of attention only appear when the dwelling is not yet fulfilling the long-term goal (implying either that it meets (i) an energy score of 100 kWh/m² primary energy consumption or (2) having U-values below 0.24 (opaque) and 1.5 (windows) with a space heating system consisting of condensation boiler, heat pump, district heating or cogeneration). As soon as the dwelling fulfils one of these two conditions, it is considered in accordance with the long-term goals and no recommendations or points of attentions appear.

The recommendations are formulated for the construction characteristics (for all building components, which are not fulfilling the long-term goal U-value) and for the space heating systems (all heating systems not meeting the long-term requirements). The further the current performance level is from the long-term goal, the higher the recommendation is prioritised. In addition, there are recommendations if no photovoltaic panels or solar collectors are installed.

The points of attention are formulated for the domestic hot water-production, the airtightness of the building envelope, the ventilation system and the risk of overheating and cooling systems. Until now, these points of attention are not very detailed and rather general. In the future we intend to develop them in more details. Current implementation:

- Domestic hot water-production: with solar system or not.
- Airtightness: infiltration rate measured or not.
- Ventilation system: heat recovery present or not, regulation of the system possible or not.
- Risk of overheating and cooling systems: indicator overheating too high or not, cooling system present or not.
- In EPC+, no (other) indicators concerning indoor air quality, thermal comfort, lighting and acoustics are foreseen. The other Flemish instrument, the Woningpas, can include these.

ii. France - P2E

The French P2E application offers the auditor the possibility to select among 33 predefined combinations of measures based on the following input variables:

- Address (or French climatic zone)
- Insulation position of wall after renovation work
- Airtightness after renovation work
- Heat system after renovation work
- Ventilation system after renovation work

These five inputs data give the following data points:

- R-Value insulation roof after work
- R-Value insulation wall after work
- R-Value insulation floor after work
- U-value windows after work
- Airtightness value after work
- Programming
- Sanitary hot water
- Heat selected just before
- Ventilation selected just before

From this information, the auditor defines the BBC renovation plan, giving the option to choose between a holistic or up to a four-steps deep-renovation approach.

For example - a building renovation roadmap in 2 steps:

- Step 1: programming, roof insulation, wall insulation, floor insulation
- Step 2: windows, ventilation, heat, sanitary hot water

iii. Germany - iSFP

The energy auditor tailors the roadmap to the specific building and the preferences of the building owner. The auditor points out all co-benefits of (deep) energy renovations, including increased comfort, accessibility, indoor air quality, etc. Figure 28 displays key indicators of the Renovation package 1. The example includes (i) current performance status, (ii) status after the first renovation step and (iii) the desired (final) status of the roadmap. The iSFP shows the same indicators as the EPC: primary energy demand and final energy demand (including auxiliary energy for pumps, fans, regulation), as well as the overall heat transfer coefficient (U-value) for different building components. Among other indicators, the roadmap includes information on the current and future CO₂-emissions, heating source and renewable energy production.

The detailed information is described with a colour scale (red to green) in the iSFP, to make it easier for the building owner to understand.

KENNWERTE MASSNAHMENPAKET 1 UND ZIELZUSTAND

Kenngrößen allgemein		ISTZUSTAND		Maßnahmenpaket 1	ZIELZUSTAND (Abschluss Maßnahmenpaket 3)
Anzahl Wohneinheiten	WE	-	2	2	2
Thermische Hüllfläche	A	m ²	678,5	678,5	678,5
Gebäudenutzfläche	A _N	m ²	228,4	228,4	228,4
Beheiztes Bruttovolumen	Ve	m ³	713,8	713,8	713,8
Kompaktheit	A / Ve	m ⁻¹	0,95	0,95	0,95
Spezifischer Jahres-Primärenergiebedarf	q _p	kWh/(m ² a)	303,4	222,7	26,2
Einsparung spezifische Primärenergie	Δ q _p	%	-	27 %	91 %
EnEV-Anforderungswert für Neubau	q _{p,ENEV,N}	kWh/(m ² a)	61,1	61,1	61,1
EnEV-Anforderungswert für Modernisierung	q _{p,ENEV,M}	kWh/(m ² a)	114	114	114
Spezifischer Transmissionswärmeverlust	H _T '	W/(m ² K)	0,821	0,559	0,2
EnEV-Anforderungswert für Neubau	H _{T,ENEV,N} '	W/(m ² K)	0,279	0,279	0,279
EnEV-Anforderungswert für Modernisierung	H _{T,ENEV,M} '	W/(m ² K)	0,56	0,56	0,56
Spezifischer Endenergiebedarf	q _E	kWh/(m ² a)	260,5	200,9	90,6
Einsparung spezifische Endenergie	Δ q _E	%	-	23 %	65 %
Spezifischer Heizwärmebedarf	q _H	kWh/(m ² a)	197,1	134,5	48,9
Kohlendioxid-Emissionen	CO ₂	kg/(m ² a)	81	57,4	3
Einsparung spezifische Kohlendioxid-Emissionen	Δ CO ₂	%	-	29 %	96 %
Luftwechselrate	n	h ⁻¹	6	6	1
Wärmebrückenzuschlag	Δ U _{WB}	W/(m ² K)	0,1	0,1	0,05

Kenngrößen Gebäudehülle				ISTZUSTAND	Maßnahmenpaket 1	ZIELZUSTAND
Dach / oberer Abschluss	Fläche	A _D	m ²	244,4	244,4	244,4
Dach / oberer Abschluss	U-Wert	U _D	W/(m ² K)	0,73	0,09	0,09
Schrägdach / OGD / Flachdach – U-Wert Anforderungen EnEV		U _{D,OGD,ENEV}	W/(m ² K)	0,24 / 0,24 / 0	0,24 / 0,24 / 0	0,24 / 0,24 / 0
Schrägdach / OGD / Flachdach – U-Wert Anforderungen KfW		U _{D,OGD,KfW}	W/(m ² K)	0,14 / 0,14 / 0	0,14 / 0,14 / 0	0,14 / 0,14 / 0
Außenwand	Fläche	A _{AW}	m ²	163,8	163,8	163,8
Außenwand	U-Wert	U _{AW}	W/(m ² K)	1,28	1,28	0,17
Außenwand – mittl. U-Wert Anforderungen EnEV/KfW		U _{m,AW,ENEV}	W/(m ² K)	0,24	0,24	0,24
Außenwand – mittl. U-Wert Anforderungen KfW		U _{m,AW,KfW}	W/(m ² K)	0,2	0,2	0,2
Wände gegen Erdreich / unbeheizt EnEV		U _{AWErde,AWUnb,ENEV}	W/(m ² K)	0,3	0,3	0,3
Wände gegen Erdreich / unbeheizt KfW		U _{AWErde,AWUnb,KfW}	W/(m ² K)	0,25	0,25	0,25
Fenster / Türen	Fläche	A _W	m ²	25,8	25,8	25,8
Fenster / Türen	U-Wert	U _W	W/(m ² K)	2,03	2,03	0,98
Fenster / Türen – mittl. U-Wert Anforderungen EnEV		U _{m,W,ENEV}	W/(m ² K)	1,4	1,4	1,4
Fenster / Türen – mittl. U-Wert Anforderungen KfW		U _{m,W,KfW}	W/(m ² K)	1,02	1,02	1,02
Dachflächenfenster	Fläche	A _{DF}	m ²	0	0	0
Dachflächenfenster	U-Wert	U _{DF}	W/(m ² K)	0	0	0
Dachflächenfenster – mittl. U-Wert Anforderungen EnEV		U _{m,DF,ENEV}	W/(m ² K)	0	0	0
Dachflächenfenster – mittl. U-Wert Anforderungen KfW		U _{m,DF,KfW}	W/(m ² K)	0	0	0
Bodenplatte / unterer Abschluss	Fläche	A _B	m ²	244,4	244,4	244,4
Bodenplatte / unterer Abschluss	U-Wert	U _B	W/(m ² K)	0,92	0,28	0,28
Bodenplatte / Kellerdecken U-Wert Anforderungen EnEV		U _{B,ENEV}	W/(m ² K)	0,3	0,3	0,3
Bodenplatte / Kellerdecken U-Wert Anforderungen KfW		U _{B,KfW}	W/(m ² K)	0,3	0,3	0,3
Kenngrößen Anlagentechnik						
Baujahr Heizung		-		1992	-	-
Leistung Heizung	P _H	kW		28	28	18
Solarer Deckungsanteil an Raumheizung		%		0 %	0 %	0 %

Kenngrößen Anlagentechnik			ISTZUSTAND	Maßnahmenpaket 1	ZIELZUSTAND (Abschluss Maßnahmenpaket 3)
Energieträger Heizung		-	Heizöl EL	Heizöl EL	Holzpellets
Primärenergiefaktor Energieträger Heizung	f_p	-	1,1	1,1	0,2
CO ₂ -Emissionsfaktor (UBA)		g/kWh	266	266	0
Weitere Heizungen vorhanden		-	-	-	-
Baujahr Warmwasser		-	1992	-	-
Solarer Deckungsanteil Warmwasser		%	0 %	0 %	0 %
Energieträger Warmwasser		-	Strom	Heizöl EL	Holzpellets
Primärenergiefaktor Energieträger Warmwasser	f_p	-	1,8	1,1	0,2
Baujahr Lüftungsanlage		-	-	-	-
Wärmerückgewinnungsgrad Lüftungsanlage		%	0 %	0 %	80 %

Figure 28: Key indicators of the renovation package 1 and target values (Source: BMWi)

IX. ANNEX C: VISUAL REPRESENTATION OF THE SELECTED BUILDING RENOVATION PASSPORTS

i. Flanders - Woningpas

The long-term goal of the Flemish renovation pact is to improve the energy performance of the existing housing stock. To visualise this path, VEA is developing a digital logbook called the Woningpas. The passport will follow the long-term evolution of each house by collecting data on energy performance, renovation advice, housing quality, other building features (stability, durability, water, installations, humidity, etc.) and other data related to the property that the building owner can safely collect and save. Building owners will be able to visualise their current energy consumption, as well as the potential savings and the proposed roadmap.

Figure 29 displays the **front page** of the Woningpas, where the user gets an overview of all needed and available certificates as well as necessary inspections, a sort of checklist to get an insight on the quality and characteristics of the building. The owner gets alert messages regarding the inspections to be carried out periodically or linked to some milestones.

The screenshot shows the front page of the Woningpas for the property 'Hogeweg 543, Kortrijk'. The page is organized into several sections:

- Header:** 'Vlaanderen WONGIPAS' and 'PETIS CONTACTEER ONZE'.
- Property Info:** 'Hogeweg 543 Kortrijk' with a link to 'Woningpas achter deuren'.
- Navigation:** 'Mijn woningpas', 'Gebouw, indeling, ligging', 'Energie', 'Isolatie & beglazing', 'Installaties', 'Bodem', 'Verunning', 'Omgiving', 'Attesten & documenten', and 'Ik ben van plan om te...'. A red notification bubble is next to 'Installaties'.
- Main Content Area:**
 - Energy:** 'Volgende' (Good). 'Jouw woning is nog niet op zijn zwaarst. Bekijk hier wat je kan doen om nog meer te besparen.' Link: 'Meer info over mijn energie'.
 - Soil:** 'Risicogrond gevonden' (Risk soil found). 'We hebben 1 van jouw percelen herkend als risicogrond. Gaak hier naar voor meer informatie.' Link: 'Meer info over mijn bodem'.
 - Insulation:** 'Matig' (Moderate). 'Gemiddeld warmteverlies door de isolatie van de woning. De muren en het dak zijn relatief goed geïsoleerd.' Link: 'Meer info over mijn isolatie'.
 - Solar Potential:** 'Zonnepotentieel' (Ideal). 'Jouw woning heeft veel zonnepotentieel. Bekijk hier wat je kan doen om de zon in huis te halen.' Link: 'Meer info over mijn zonnepotentieel'.
 - Installations (Heating):** 'Alle installaties zijn gekeurd' (All installations checked). 'Sommige installaties dienen periodiek gekeurd te worden.' Link: 'Meer info over mijn keuringen'.
 - Installations (Water):** 'Installaties' (Installations). 'Verwarminginstallatie: 2 tontalen. Sanitair warm water: 1 tontal.' Link: 'Meer info over mijn installaties'.
 - Advices:** 'Adviezen' (Advice). 'We hebben de adviezen uit jouw EPC ook nog eens hier verzameld. Neem zeker een kijkje hoe je jouw woning kan verbeteren op vlak van energieverbruik en comfort.' Link: 'Toon mijn persoonlijke adviezen'.
 - Planning:** 'Plannen?' (Plan?). 'Kijk hier naaraan je moet voldoen of welke stappen je moet ondernemen bij verbouwen, verkopen, verhuren, kopen...' Link: 'Toon mijn stappenplan'.
- Footer:** 'Vlaanderen' logo, 'Dit is een officiële website van de Vlaamse overheid', 'over woningpas', 'disclaimer', and 'toegankelijkheid'.

Figure 29: Woningpas – overview, front page (Source: Flemish Energy Agency)

Figure 30 shows the user the **Energy Performance Certificate** of the building, including information on energy consumption, building performance and basic information about the building.

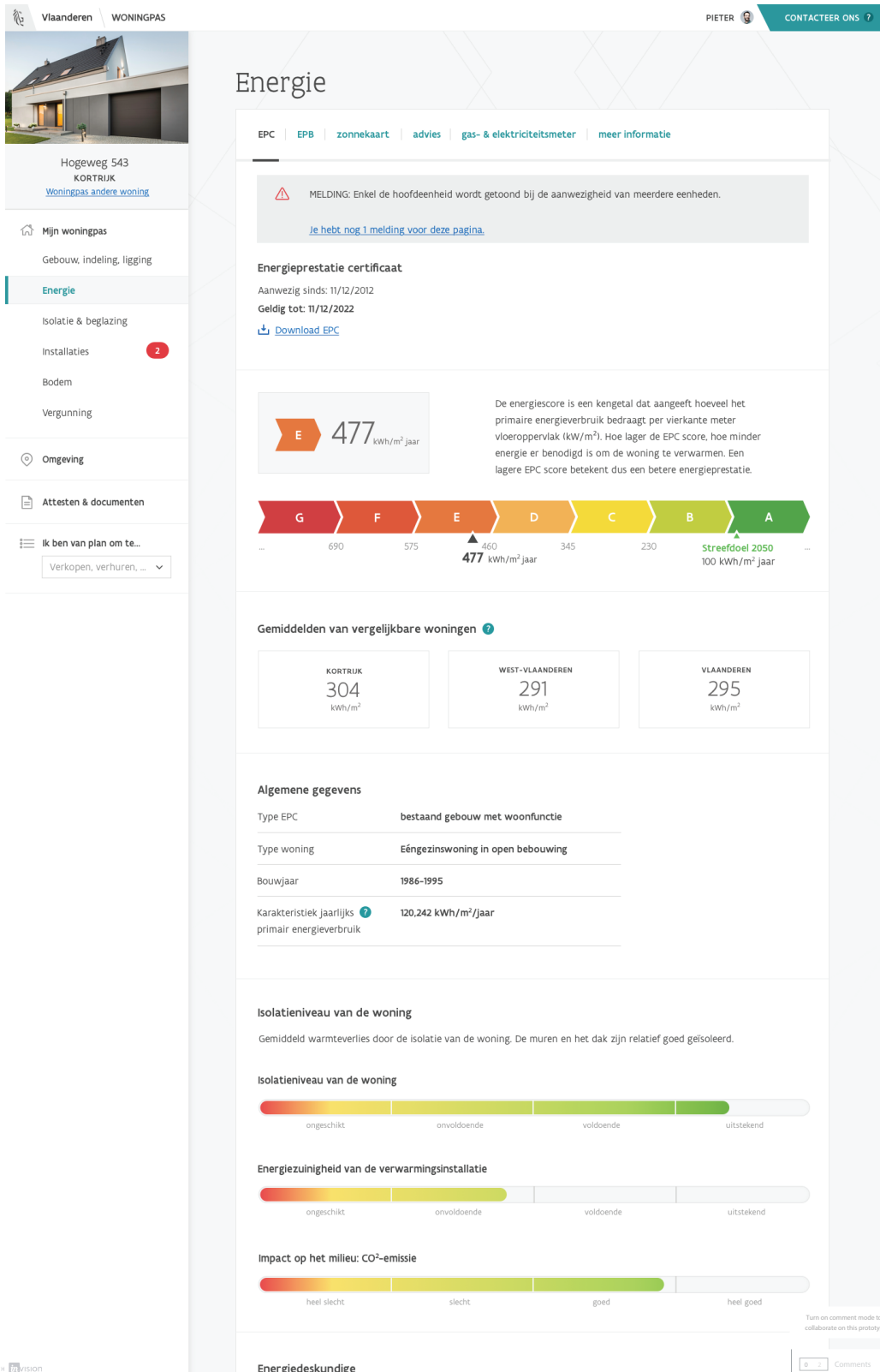
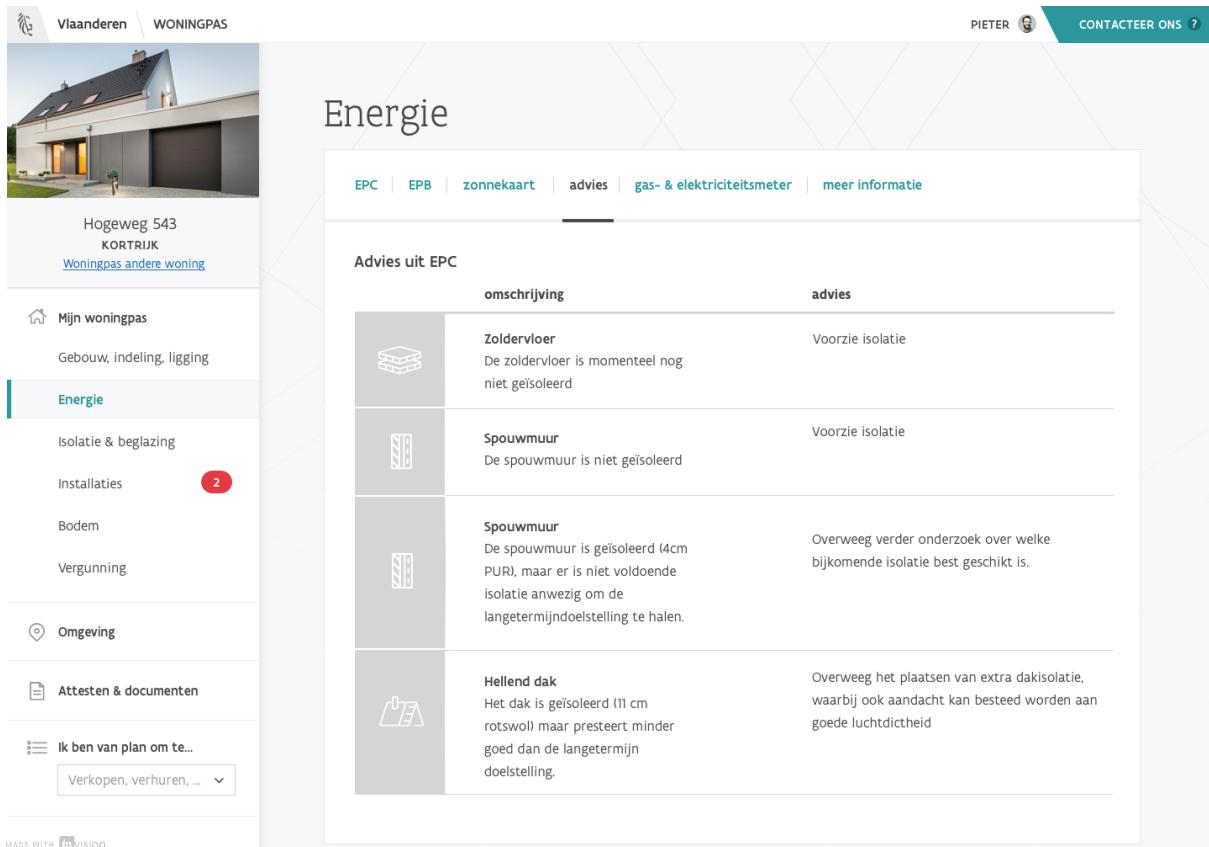

Figure 30: Woningpas - Energy Performance Certificate (Source: Flemish Energy Agency)

Figure 31 displays the **renovation advice**, which aims to give property owners an insight into the logic of renovation steps as a means to achieve Flanders' long-term objective of an energy-efficient housing stock: by 2050, the existing building stock should become as energy-efficient as new buildings today. It includes the recommendations included in the EPC+.



The screenshot shows the 'Energie' (Energy) section of the Woningpas application. The left sidebar contains navigation options: 'Mijn woningpas', 'Energie', 'Omgeving', 'Attesten & documenten', and 'Ik ben van plan om te...'. The main content area is titled 'Energie' and includes a breadcrumb trail: 'EPC | EPB | zonnekaart | advies | gas- & elektriciteitsmeter | meer informatie'. Below this, there is a table titled 'Advies uit EPC' (Advice from EPC) with the following data:





	omschrijving	advies
	Zoldervloer De zoldervloer is momenteel nog niet geïsoleerd	Voorzie isolatie
	Spouwmuur De spouwmuur is niet geïsoleerd	Voorzie isolatie
	Spouwmuur De spouwmuur is geïsoleerd (4cm PUR), maar er is niet voldoende isolatie aanwezig om de langetermijndoelstelling te halen.	Overweeg verder onderzoek over welke bijkomende isolatie best geschikt is.
	Hellend dak Het dak is geïsoleerd (11 cm rotswol) maar presteert minder goed dan de langetermijn doelstelling.	Overweeg het plaatsen van extra dakisolatie, waarbij ook aandacht kan besteed worden aan goede luchtdichtheid

Figure 31: Woningpas - energy overview (Source: Flemish Energy Agency)

Figure 32 shows the **renovation plan of the building**. The Woningpas is designed to be a 'living' document that can easily be kept up-to-date.

Ik ben van plan om te verbouwen

Ik ben van plan om te...

Verbouwen

Lorem ipsum dolor sit amet, consectetur adipiscing elit. Donec id elit non mi porta gravida at eget metus. Maecenas sed diam eget risus varius blandit sit amet non magna. Nullam id dolor id nibh ultricies vehicula ut id elit. Maecenas faucibus mollis interdum. Nullam quis risus eget urna mollis ornare vel eu leo. Maecenas sed diam eget risus varius blandit sit amet non magna.

In order te brengen VOOR verbouwingen (1)

Aanwezig in woningpas	Attestnaam	Verantwoordelijke	
✓	Bouwaanvraag Steeds verplicht Open jouw document	Eigenaar	Details

In order te brengen TIJDENS verbouwingen (0)

✓	EPB aangifte Steeds verplicht	Eigenaar	Details
✗	Conformiteitsattest stookolietank Steeds verplicht Open jouw document	Eigenaar	Details
?	Attest van buitengebruikstelling stookolietank Steeds verplicht Open jouw document	Eigenaar	Details
?	Airconditioningsinstallatie >12 kW Steeds verplicht Open jouw document	Eigenaar	Details
?	Binneninstallatie voor drinkwater Steeds verplicht Open jouw document	Eigenaar	Details
?	Privéwaterafvoer Steeds verplicht Open jouw document	Eigenaar	Details
?	Keuringsattest elektrische installatie van na 01/10/1981 Steeds verplicht Open jouw document	Eigenaar	Details
?	Keuring gasinstallatie Steeds verplicht Open jouw document	Eigenaar	Details

In order te brengen NA verbouwen (0)

Je hoeft geen documenten in orde te brengen tijdens het verkopen van je woning.

Figure 32: Woningpas - "I am planning to renovate", renovation plan (Source: Flemish Energy Agency)

Figure 33 shows the section of the Woningpas where **building-related documents can be saved** and later easily retrieved.

Vlaanderen WONINGPAS

PIETER CONTACTEER ONS ?

Attesten & documenten

PDF overzicht Upload

Attesten van de overheid 8 Eigen uploads 2

Uploads van de overheid

Sorteer op: bijna vervallen ▾

EPB-aangifte De EPB-aangifte is een conformiteitsdossier dat bij de overheid wordt ingediend wordt voor een bouwproject waarvoor EPB-eisen gelden.	Geldig tot 05/03/2017	Details
Bodemattest De EPB-aangifte is een conformiteitsdossier dat bij de overheid wordt ingediend wordt voor een bouwproject waarvoor EPB-eisen gelden.	Geldig tot 13/11/2028	Details

Vlaanderen
verbeelding werkt

Dit is een officiële website van de Vlaamse overheid
Uitgegeven door Vlaams Energie Agentschap, Openbare Vlaamse Afvalstoffenmaatschappij, Wonen Vlaanderen en Departement Omgeving

over woningpas disclaimer toegankelijkheid

Figure 33: Woningpas - certificates and documents (Source: Flemish Energy Agency)

ii. Flanders - EPC+

The EPC+ is an enhanced version of the EPC aiming not only at informing potential buyers of the energy value of a property, but at providing them with a very clear picture of what is needed to achieve a future-proof energy-efficient standard (E60 by 2050). The potential buyers will be informed on the best options for the energy renovation of the property they are interested in.

Figure 34 displays the front page of the EPC+, including a visualisation of current and future (potential) energy performance level.

Energieprestatiecertificaat

Bestaand gebouw met woonfunctie



Energiescore



Verklaring van de energiedeskundige

Ik bevestig dat alle gegevens op dit certificaat overeenstemmen met de werkelijke uitvoering (afmetingen, materialen, installaties).

Datum 26/10/2012

Handtekening:

Jan Peters

Dit certificaat is geldig tot en met **20 juli 2022**

Figure 34: EPC+ - Front page (Source: Flemish Energy Agency)

The second page of the EPC+ (see Figure 35) visualises the **current building performance status** of the building and highlights various issues/aspects where improvements are needed. The first section provides an overall summary, while the second section describes the performance of different building components (the floor is the only component meeting the set requirements in the illustration below).

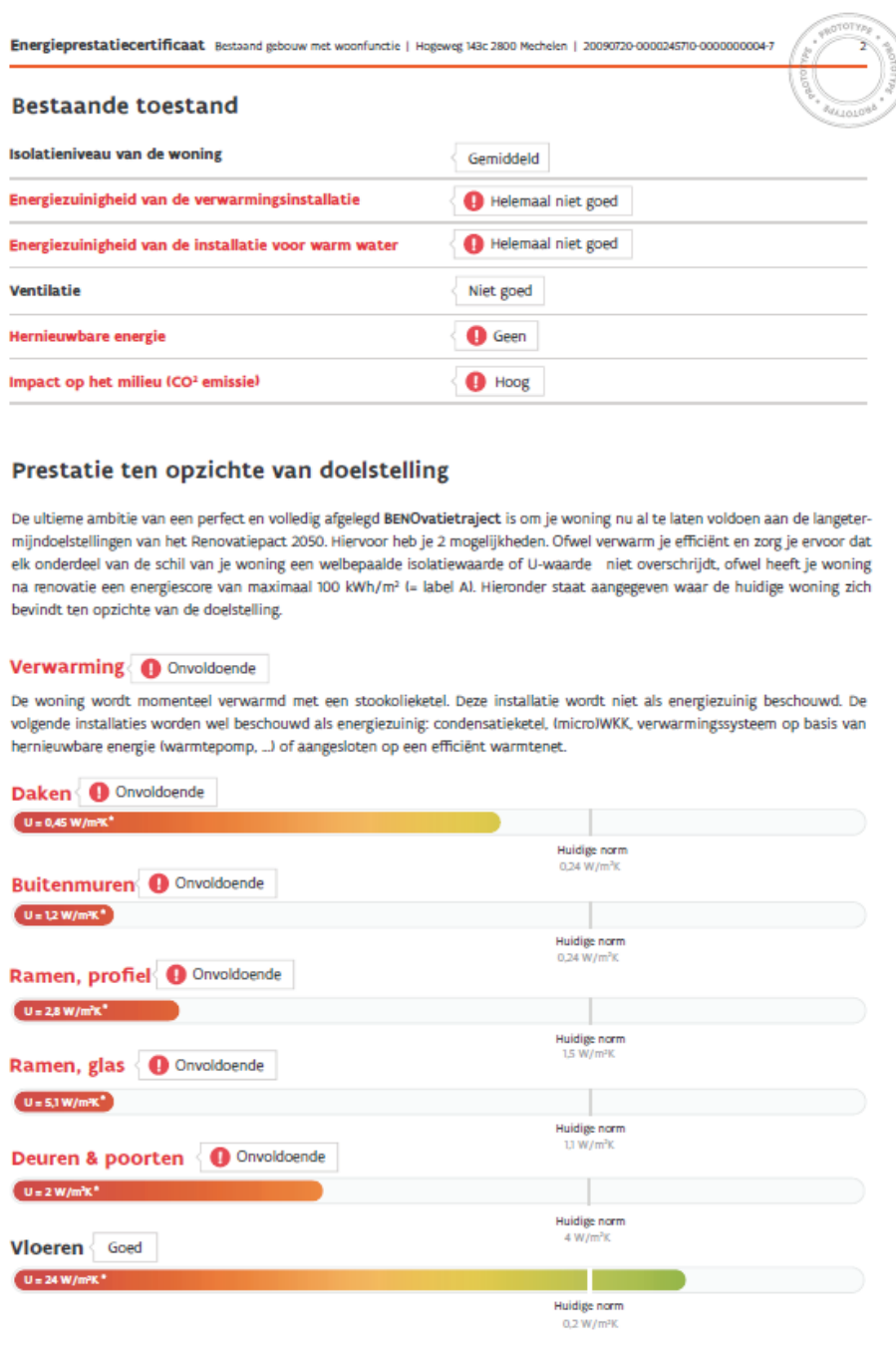

Figure 35: EPC+ Energy performance of building components (Source: Flemish Energy Agency)

The next page of the EPC+ shows an overview of the **step-by-step recommendations**. The overview includes details on the current status, recommendations, expected cost for the measure and energy performance label after the measure been executed. It also includes a “point of attention” highlighting the importance of ventilation in an energy efficient dwelling.

Energieprestatiecertificaat Bestaand gebouw met woonfunctie | Hogeweg 143c 2800 Mechelen | 20090720-0000245710-0000000004-7

PROTOTYPE • PROTOTYPE • PROTOTYPE
3

Overzicht aanbevelingen

	HUIDIGE SITUATIE	AANBEVELING	PRIJSSCHATTING	LABEL NA RENOVATIE
1	Ramen Er is momenteel nog overal enkele beglazing aanwezig	Plaats nieuw schrijnwerk met hoogrendements beglazing	€ 8000 - € 12 000	D
	Verwarming Ketel is sterk verouderd en niet energiezuinig.	Plaats een efficiënt verwarmingssysteem	€ 4500 - € 6500	D
2	Muur De muur is niet geïsoleerd voor een gedeelte van 147m ²	Plaats isolatie	€ 13 500 - € 15 000	B
	Hellend dak Het dak is beperkt geïsoleerd.	Plaats bijkomende isolatie	€ 12 000 - € 16 000	B
3	Hernieuwbare energie Er is geen hernieuwbare energie aanwezig	Overweeg plaatsing hernieuwbare energie	€ 7500 - € 10 000	A
4	Muur De muur is geïsoleerd (voor een gedeelte van 63m ²), maar er is niet voldoende isolatie aanwezig om de lange termijn doelstelling te halen.	Overweeg bijkomende isolatie op het moment dat deze muur gerenoveerd wordt.		A

1	Prioriteit 1 Niet goed, zo snel mogelijk te renoveren.	2	Prioriteit 2 Te renoveren.	3	Prioriteit 3 Interessant te overwegen.	4	Prioriteit 4 Redelijk goed, puur energetische renovatie, niet aange- wezen.
---	--	---	--------------------------------------	---	--	---	--

Volgorde van de werken & prijsinschatting

De prioriteiten zijn automatisch bepaald op basis van hoofdzakelijk energetische aspecten. De prioriteiten komen niet noodzakelijk overeen met de optimale volgorde om de werken uit te voeren. De prijs is afhankelijk van verschillende factoren die niet allemaal ingerekend zijn. Om meer inzicht te krijgen in de beste volgorde, maakt u best een persoonlijk renovatieadvies op. Zie verder voor meer informatie.

! Aandachtspunt: ventilatie

Bij een renovatie besteedt u best de nodige aandacht aan ventilatie omdat . Nulet si amet. Maecenas faucibus mollis interdum. Sed posuere consectetur est at lobortis. Nulla vitae elit libero, a pharetra augue.

Personaliseer uw renovatie-advies











De aanbevelingen uit het EPC en deze bijlagen zijn automatisch gegeneerd op basis van de energetische toestand van het gebouw. U kan uw advies gratis zelf personaliseren naar uw wens of behoeften op www.xyz_renovatieadvies.be. Nulet si amet doloris Aenean lacinia bibendum nulla sed consectetur.

Figure 36: EPC+ - Overview of suggested renovation measures (Source: Flemish Energy Agency)

Figure 37 displays the **renovation path of the building**, which includes the energy performance level and related energy use after each renovation step (see Figure 37). The page also includes a list of 10 good reasons to renovate.



10 goede redenen om nu al te benoveren

- | | |
|---|---|
|  1. Een lagere energiefactuur |  6. Nodig voor ons klimaat |
|  2. Meer comfort |  7. Je woning klaar voor je oude dag |
|  3. Een gezonder binnenklimaat |  8. Minder onderhoud |
|  4. Esthetische meerwaarde |  9. Vandaag al haalbaar |
|  5. Financiële meerwaarde |  10. De overheid betaalt mee |

Meer informatie over het EPC van jouw woning of over Benoveren vind je op de website www.energiesparen.be. Hieronder vindt u al een greep uit het informatieaanbod op de website.

The big Picture

Bij het kopen, huren of renoveren van een woning komt er meer kijken dan enkel energie. Via de website www.energiesparen.be kan u meer te weten over een breder duurzaamheidsadvies of kan u leren om uzelf de juiste vragen te stellen over andere aspecten van woningkwaliteit.

Tips voor een goed gebruikersgedrag

De energiescore is berekend op basis van een standaardgebruik. Het werkelijke energieverbruik wordt echter ook beïnvloed door de gebruikers en de manier waarop wordt omgesprongen met energie. Op de website www.energiesparen.be vindt u tips voor een goed gebruikersgedrag.



Premies & fiscale aftrek

Informatie over energiewinsten, subsidies of andere financiële voordelen vindt u op www.energiesparen.be

Figure 37: EPC+ - Energy performance before and after implementation of measures
(Source: Flemish Energy Agency)

The last page of the EPC+ (Figure 38) contains the **general information**, including (i) about your EPC+, long-term objective, validity, disclaimer and details to the energy expert.

Energieprestatiecertificaat Bestaand gebouw met woonfunctie | Hogeweg 143c 2800 Mechelen | 20090720-0000245710-0000000004-7



Over het EPC+

De energiescore en het energielabel van deze woning zijn bepaald via een theoretische berekening op basis van de bestaande toestand van het gebouw. Er is geen rekening gehouden met het gedrag en werkelijk energieverbruik van de (vorige) bewoners. Hoe lager de energiescore hoe beter.

De referentie score laat toe een vergelijking te maken met een vergelijkbare woning. In dit geval is de referentie de gemiddelde Vlaamse halfopen woningen op het moment dat het EPC werd opgemaakt.

Langetermijndoelstelling 2050

Tegen 2050 moet elk huis en appartement even energiezuinig zijn als een energetisch performante nieuwbouw woonst van vandaag. Deze ambitie van de Vlaamse overheid is broodnodig in de strijd tegen de klimaatverandering. Het is ook de enige garantie op een betaalbare energiefactuur en energieonafhankelijkheid.

Om deze doelstelling te behalen moeten we anders gaan denken over onze woonst. Durf daarom nu al vooruit te denken bij uw keuze van energiebesparende maatregelen. Ga verder dan wat momenteel wettelijk verplicht is. Je zal onmiddellijk kunnen genieten van de vele voordelen van een energetisch performante woonst: een lagere energiefactuur, meer comfort, een gezond binnenklimaat, financiële en esthetische meerwaarde, minder onderhoud en meer gebruiksgemak op latere leeftijd.

Geldig tot 20 juli 2022

Een EPC+ is verplicht bij het verhuren en verkopen. Dit certificaat is geldig tot 20 juli 2022. Indien je de woning na deze datum niet verhuurt of verkoopt, hoeft je geen nieuw certificaat aan te vragen. Verkoop of verhuur je je woning wel voor 20 juli 2022, en voerde je energiebesparende renovatiewerken uit? Vraag dan een nieuw energieprestatiecertificaat aan. Een betere energiescore kan invloed hebben op de waarde van uw woonst.

Meer info?

Meer info over jouw woning vind je op de woningpas. surf naar www.link.be of scan onderstaande QR-code.



Disclaimer

De aanbevelingen op het energieprestatiecertificaat zijn standaardaanbevelingen, die door de software gegenereerd worden op basis van de invoergegevens van de energiedeskundige volgens een door de Vlaamse overheid vastgelegde werkwijze. Mogelijk zijn een aantal standaardaanbevelingen praktisch niet uitvoerbaar of risicovol. Soms zijn bij de uitvoering aanvullende aanbevelingen nodig om de kwaliteit van het binnenmilieu of het comfort te behouden of te verbeteren. Verder onderzoek door een adviseur, architect, installateur of aannemer is in sommige gevallen vereist. De opsteller kan niet aansprakelijk gesteld worden voor de schade die ontstaat als de geadviseerde aanbevelingen zonder nader onderzoek of ondeskundig uitgevoerd worden. De energiedeskundige kan bijkomende opmerkingen of aanbevelingen aan de standaardaanbevelingen toevoegen. U vindt die onder 'Aanbevelingen en opmerkingen van de energiedeskundige'.

Energiedeskundige

Erkenningscode	EP00000
Voornaam	Jan
Naam	Peters
Postcode	xxxx
Gemeente	Zwijnegem
Straatnaam	Kerkstraat
nummer + bus	3/1
Land	België

Figure 38: EPC+ - About your EPC+ (Source: Flemish Energy Agency)

Figure 39 and Figure 40 show an example of a recommendation targeting the windows of the building. The information includes (i) the cost of the measure, (ii) technical details, (iii) energy performance improvements (kWh / m² / year) and a (iv) “think ahead” section, which in the example below highlights the importance of a good ventilation system when the dwelling becomes more efficient.



* De U-waarde geeft de hoeveelheid warmte aan die per seconde, per m² en per graad (Celsius of Kelvin) temperatuurverschil tussen de ene en de andere zijde van een wand doorgelaten wordt. Hoe lager de waarde, hoe beter de thermische isolatie.

Figure 39: EPC+ - detailed recommendation 1 (Source: Flemish Energy Agency)



sten en extra daglicht binnenhaalt. Heb je niet onmiddellijk budget voor geautomatiseerde buitenzonwering? Voorzie dan nu al de nodige elektrische aansluiting. Zo vermijd je kap- en breekwerk achteraf. Ook bomen en groen kunnen zorgen voor de nodige beschaduwing in de zomer.

Zelfs als je kiest voor hoogrendementsbeglazing kan de U-waarde* van een venster (U_w) sterk variëren naargelang de gebruikte profielen. Hout is van nature de beste isolator, maar aluminium en pvc blijven tegenwoordig niet ver achter. Producenten van pvc en aluminiumprofielen ontwikkelen de laatste jaren steeds meer technologieën die de isolatieprestaties van hun profielen verder verbeteren, zoals versterkingen met continue glasvezels in plaats van staal, of extra 'kamers' (onderverdelingen in het profiel). Profielen met vijf kamers hebben een lagere U-waarde* en isoleren dus beter dan profielen met slechts twee kamers. Ook de isolatiewaarde (U_i) van houten ramen wordt steeds beter.



Denk vooruit

Wanneer je een woning energiezuiniger maakt, wordt die meteen ook luchtdichter*. Je dicht immers de spleten en kieren af waarlangs er warmte kan ontsnappen, maar tegelijk sluit je alle natuurlijke luchtopeningen af. Daarom is het van cruciaal belang dat er goed geventileerd kan worden. Nieuwe ramen geven je de kans om op een vrij eenvoudige manier regelbare ventilatieroosters te voorzien.

Prijsberekening

In de prijsberekening zitten volgende raamdelen

- 45m² raampartijen zuidkant
- 10m² raampartijen noordkant
- 15m² raampartijen oostkant

In de berekening zijn volgende kosten opgenomen

Lorem ipsum dolor sit amet	€ xyz - € xyz
Bibendum Aenean Ridiculus Vehicula	€ xyz - € xyz
Ultricies Consectetur Malesuada	€ xyz - € xyz
Totaalprijs	€ xyz - € xyz

ⓘ Let op, kosten kunnen afwijken omwille van Morbi leo risus, porta ac consectetur ac, vestibulum at eros.

Volgende kosten maken geen deel uit van de berekening

- Stellingen
- Ridiculus Fusce

Energiebesparing door het vervangen van de ramen



xyz kWh / m² / jaar

Deze renovatie zorgt voor een daling in het EPC van xyz kWh / m² / jaar

Figure 40: EPC+ - detailed recommendation 2 (Source: Flemish Energy Agency)

iii. France - Passeport Efficacité Énergétique (P2E)

The passport is designed for three specific users: owners, auditors and craftsmen, and renovation professionals. There are different login pages for different type of users, the login page for building owners is displayed in Figure 41.

The screenshot shows the P2E login page for individual users. At the top left is the logo 'PASSEPORT EFFICACITÉ ÉNERGÉTIQUE BETA'. A green notification bar at the top says 'Vous êtes déconnecté.' Below this, there are three tabs: 'Espace particulier' (selected), 'Espace auditeur', and 'Espace artisan'. The main heading is 'Valoriser votre logement.' followed by 'Confort, Performance énergétique, Projets.' There are three main sections: 1. 'Diagnosticuez le niveau de confort et de performance énergétique de votre logement.' with a bar chart icon and text about pre-diagnostic solutions. 2. 'Partagez votre dossier « logement » avec les professionnels du bâtiment.' with a people icon and text about sharing with auditors, architects, and craftsmen. 3. 'Pilotez la valorisation de votre logement.' with a lightbulb and calculator icon and text about a unique dashboard. A 'S'inscrire gratuitement' button is at the bottom. On the right, there is a 'Connexion Particulier' form with fields for 'email' and 'mot de passe', a 'Se souvenir de moi' checkbox, a 'Mot de passe oublié ?' link, and a green 'Connexion' button.

Figure 41: P2E - login page (Source: Expérience P2E)

The **dashboard** of the P2E (see Figure 42) shows an overview of all the main elements taken into account: energy, comfort, detailed features, valuation, financial aspects and files storage. The energy efficiency level of each element of the building is displayed on the dashboard based on the evolution of the energy renovation (e.g. to be planned, planned, ongoing, completed). Details for each element (architectural and technical features, etc.) are available in separate pages of the website.



Figure 42: P2E - dashbord overview (Source: Expérience P2E)

Figure 43 displays an overview of “existing assets”, with basic information about the different buildings.

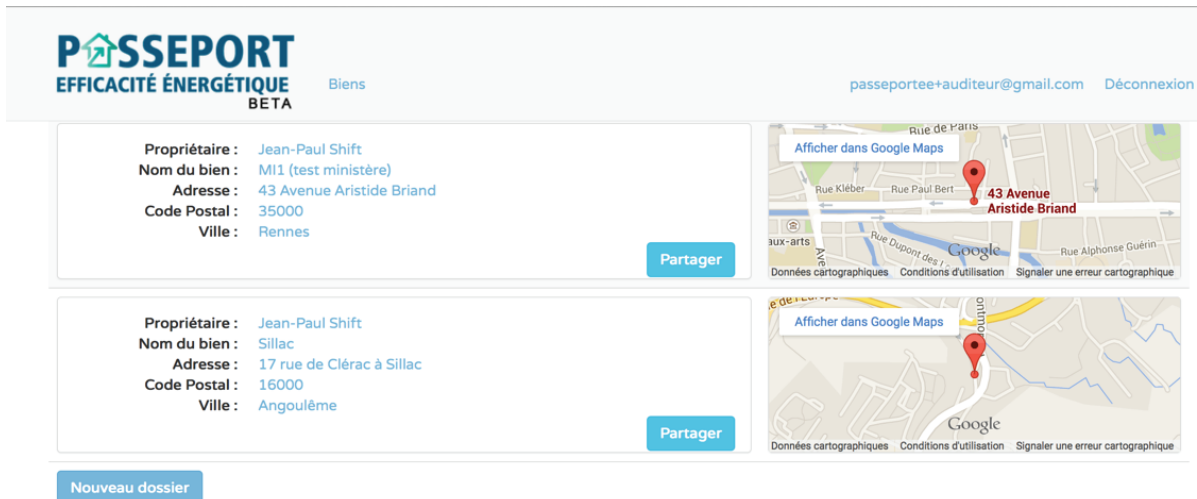

Figure 43: P2E - Overview of existing assets (Source: Expérience P2)

Figure 44 and Figure 45 show two questionnaires that are designed to assist the energy auditor. The first one finds out if the building owner is eligible for financial support, which can be determinant for how the owner wants to invest in energy efficiency. The second questionnaire focuses user behaviour and comfort, which helps the auditor to better tailor the roadmap.

The screenshot shows the 'Passeport Efficacité Énergétique BETA' web application. The main navigation bar includes 'Tableau de bord', 'Généralités', 'Performance énergétique', and 'Choix & travaux'. The 'Choix & travaux' section is active, showing a sidebar with options: 'Choix & travaux', 'Choix combinaison de performance', 'Aspects financiers', 'Confort', 'Etanchéité', and 'Prévision de travaux'. A green button 'Lancer le calcul' is visible. The main content area is titled 'Questionnaire financier' and is divided into three sections: 'Energie', 'Foyer fiscal', and 'Capacité de financement'. The 'Energie' section includes 'Contrat électricité' (Electricité bleu option base 6kVa) and 'Contrat gaz'. The 'Foyer fiscal' section includes 'Situation familiale' (Marié) and 'Nombre d'enfant à charge' (3). The 'Capacité de financement' section includes 'Revenu du ménage N-2' (60000 €), 'Epargne mobilisable' (10000 €), 'Prêt en cours' (Non selected), and 'Estimation de la valeur du bien' (600000 €). At the bottom, there are 'Annuler' and 'Enregistrer' buttons.

PASSEPORT
EFFICACITÉ ÉNERGÉTIQUE
BETA

Biens

passeeportee+auditeur@gmail.com Déconnexion

Tableau de bord Généralités Performance énergétique Choix & travaux

Choix & travaux

> Choix combinaison de performance

> Aspects financiers

> Confort

> Etanchéité

> Prévision de travaux 8

Lancer le calcul

Questionnaire financier

Energie

Contrat électricité

Electricité bleu option base 6kVa

Contrat gaz

Foyer fiscal

Situation familiale

Marié

Nombre d'enfant à charge

3

Capacité de financement

Revenu du ménage N-2 :

60000 €

Epargne mobilisable :

10000 €

Prêt en cours :

Oui

Non

Estimation de la valeur du bien :

600000 €

Annuler Enregistrer

Figure 44: P2E - financial aspect: is the individual eligible for public support/aid (Source: Expérience P2E)



Biens

passeportee+auditeur@gmail.com Déconnexion

Tableau de bord
Généralités
Performance énergétique
Choix & travaux

Choix & travaux

> Choix combinaison de performance

> Aspects financiers

> Confort

> Etanchéité

v Prévission de travaux 8

Lancer le calcul

Questionnaire confort

Confort d'hiver

Température du séjour en journée :

 °C

Température du séjour la nuit :

 °C

Confort d'hiver

Autres problèmes ressentis :

- Ne parviens à se chauffer
- Tout le temps chaud
- Sensation de froid par infiltration
- Sensation de froid à proximité des ouvrants
- Sensation de froid à proximité des murs
- Sensation de froid à proximité du sol
- Autre - Saisie libre

Lorsque j'ai trop chaud :

- Je me dévêtis légèrement
- J'ouvre les fenêtres
- Je me réhydrate régulièrement
- Je ferme tout ou partie des radiateurs

Que pensez-vous qu'il faille faire en priorité pour réduire l'inconfort ?

Figure 45: P2E - questionnaire on confort (Source: Expérience P2E)

Figure 46 displays two different **energy performance combinations** (roadmaps) for the owner to choose from.



Biens passportee+auditeur@gmail.com Déconnexion

Tableau de bord Généralités Performance énergétique Choix & travaux

Choix & travaux

- > Choix combinaison de performance
- > Aspects financiers
- > Confort
- > Etanchéité
- > Prévission de travaux 8

Lancer le calcul

Solutions

	Classe	N°	Isolation	Etanchéité	Murs	Plancher	Toiture	Ouvrants	Ventilation	Chaudière Gaz	Chaudière Fioul	Chaudière Electrique	Chaudière Bois	Poêle/insert Bois
<input checked="" type="radio"/>	B	3	INT	3	7.5	6.5	10.0	1.1	HYGRO	OUI	OUI	OUI	OUI	OUI
<input type="radio"/>	B	5	INT	3	6.0	4.5	10.0	0.8	HYGRO	OUI	OUI	OUI	OUI	OUI

Valider

POUR LE BIEN DE VOTRE IMMOBILIER

Vue à 360° des caractéristiques du bien.
Amélioration de sa performance énergétique.
Stockage gratuit & illimité des données.

UNE SOLUTION INNOVANTE

Facile d'utilisation.
Collaborative.
Accessible de tout type d'appareil.
Sécurisée.
Réglementaire.

A PROPOS

Qui sommes-nous ?
Conditions générales d'utilisation.
Mentions légales.

Figure 46: P2E - choice of different building performance combinations (Source: Expérience P2E)

iv. Germany - Mein Sanierungsfahrplan (iSFP)

The iSFP sets out an individual tailored roadmap for the building owner, based on an energy audit and dialogues with the owner. Figure 47 displays the **front page** including a picture of the building.



Figure 47: iSFP - Front page (Source: BMWi)

The second page of the iSFP (Figure 48) shows **“your house today”**, which identifies various points of attention. The example includes thermal bridges, windows and un-insulated basement floor. The section also contains general information of the building (year built, size, etc.).

IHR HAUS HEUTE

Im Rahmen der Vor-Ort-Analyse des Gebäudes wurden die hier dargestellten baulichen Ausgangsbedingungen vorgefunden.



heutige Isolierglasfenster



Wärmebrücke Erker



ungedämmte Kellerdecke



kleinere Putzschäden

Gebäudedaten	
Standort	Musterstadt
Gebäudetyp	Einfamilienhaus
Baujahr	1935
geschätzte Wohnfläche	158 m ²
Vollgeschosse	2
Keller	unbeheizt
Dach	beheizt
Baujahr der Heizung	1992
Bisher durchgeführte Sanierungen	Fenster (1992-94), Dachausbau (1994), Außenwände (1992)
Nutzung erneuerbarer Energien	-



vorhandener Heizkessel

Figure 48: iSFP – “Your house today”, current status (Source: BMWi)

Figure 49 displays the **energy performance of the different components** of the building, including walls, roof, ventilation, windows, domestic hot water, floor, heating and distribution of heat. The iSPF uses a simple colour scale to visualise the current status of each component.

ENERGETISCHER ZUSTAND

ÜBERBLICK ZUM ISTZUSTAND UND SANIERUNGSBEDARF IHRES HAUSES:

Skala zur Energieeffizienz:

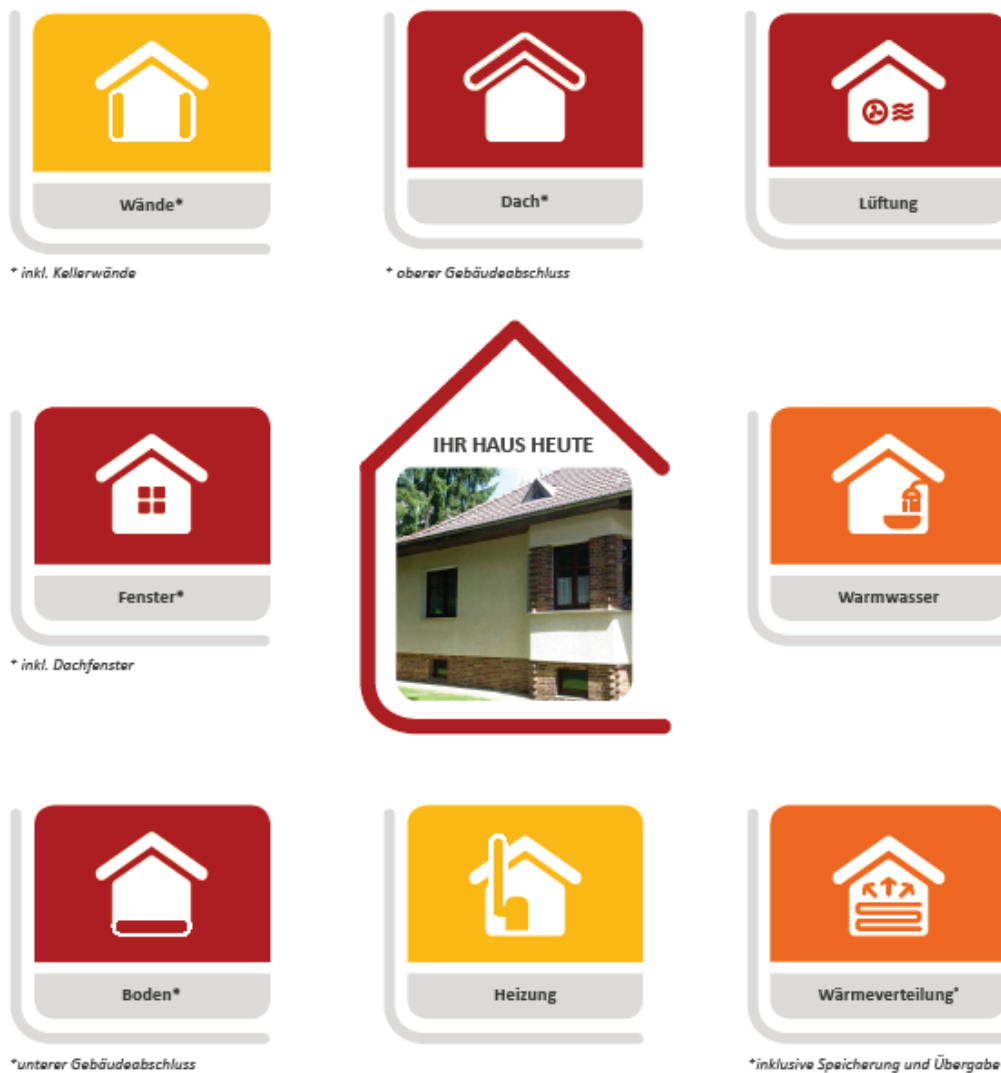

Die Gebäudesubstanz weist an mehreren Stellen Mängel auf, eine umfassende Gebäudediagnose wird empfohlen.

Figure 49: iSPF - energy situation (Source: BMWi)

Figure 50 shows “**your individual user influence**” and “**use recommendations for you**”. The first section describes different user behaviour characteristics (preferred temperature, use of hot water, etc.). In the example below, the real energy consumption is lower than the calculated one, which is explained by the fact that the users are absent a lot during the weekdays (i.e. less heating needed) and that the rooms in the attic are rarely used and therefore do not require to be heated.

The second part includes recommendations regarding user behaviour.

IHR INDIVIDUELLER NUTZEREINFLUSS

Durch Ihr Verhalten beeinflussen Sie die Nutzung von Energie und das Raumklima maßgeblich.

Einflüsse	Ihre Gewohnheiten
Raumtemperatur	18,5 °C, bei Anwesenheit 21°C
Anwesenheit	berufstätig
Art der Raumnutzung	Räume im Dachgeschoss derzeit wenig genutzt
Warmwasser	tägliches Duschen
Lüftungsverhalten	Lüften durch Kippen
Berechneter Endenergiebedarf	46.600 kWh/a
Ermittelter Endenergieverbrauch	34.600 kWh/a
Fazit	Ihr Energieverbrauch für Heizung und Warmwasser liegt ca. 25 % unter dem berechneten Energiebedarf des Gebäudes. Grund dafür ist der Unterschied zwischen den angesetzten Standardrandbedingungen für die Berechnung und ihrem individuellen Nutzerverhalten. So sind Sie an Wochentagen berufsbedingt viel abwesend und heizen die Räume weniger. Zudem werden die Räume im Dachgeschoss nur selten genutzt und deshalb wenig geheizt.

NUTZUNGSEMPFEHLUNGEN FÜR SIE

Eine sofortige Energieeinsparung können Sie durch ein bewusstes Nutzerverhalten erreichen.

- Lüften Sie in den kalten Jahreszeiten lieber nur mit kurzen Stoßlüftungen. Wenn Ihre Fenster länger in der Kippstellung sind, steigen Ihre Heizkosten und es besteht die Gefahr, dass sich an den Fensterstürzen Schimmel bildet.
- Beim Lüften sollten Sie die Thermostatventile am Heizkörper zudrehen. Die einströmende kalte Außenluft bewirkt sonst, dass sich das Ventil selbstständig öffnet und unnötig Wärme nach außen dringt.
- Achten Sie beim Stoßlüften auf die Innentüren. Wenn Sie beispielsweise morgens die Schlafräume lüften, können die Innentüren offen bleiben. Der Luftwechsel wird dann wesentlich größer, vor allem bei weit geöffneten Fenstern. Wenn Sie hingegen Bad und Küche wegen kurzzeitiger hoher Luftfeuchtigkeit lüften, sollten die Innentüren geschlossen bleiben.
- Heizkörper nicht durch Vorhänge oder Verkleidungen verdecken oder mit Möbeln zustellen.
- Dichten Sie undichte Fenster ab – auch wenn Sie ohnehin ausgetauscht werden sollen. Hier genügt zunächst eine einfache Dichtung aus dem Baumarkt.
- Eine Absenkung der Raumtemperatur bei Abwesenheit und innerhalb der Nachtstunden hilft beim Energiesparen. Moderne Heizsysteme verfügen über eine Zeitsteuerung, an der Tag- und Nachtzeiten eingestellt werden können. Achten Sie jedoch auf eine nur geringe Absenkung der Temperatur, damit sich die Wände nicht zu stark abkühlen, denn kalte Wandflächen haben großen Einfluss auf die Behaglichkeit.

Figure 50: iSFP - your individual user behaviour and related recommendations (Source: BMWi)

Figure 51 and Figure 52 outlines “your next steps”, including information on how to start the renovation process and a visualisation of the long-term plan for the building.

IHRE NÄCHSTEN SCHRITTE

SO STARTEN SIE IHRE SANIERUNG

- Bereiten Sie auf der Grundlage Ihres Sanierungsfahrplans die jeweiligen Sanierungsschritte gut vor. Im Teil „Umsetzungshilfe für Ihre Maßnahmen“ finden Sie Erläuterungen und Hinweise zu jeder empfohlenen Effizienzmaßnahme.
- Bei einigen Maßnahmen finden Sie die Empfehlung für eine genauere Analyse eines Bauteils oder sogar für eine umfassende Gebäudetechnische Analyse. Beauftragen Sie dafür vor der Ausführung von Maßnahmen entsprechende Fachplaner. Ich berate Sie gerne dabei.
- Es gibt verschiedene bundesweite und regionale Förderprogramme. Gerne unterstütze ich Sie bei der Beantragung von Fördermitteln. Für die Beantragung von KfW-Förderung ist die Einbindung eines gelisteten Energieeffizienz-Experten zwingend erforderlich.
- Sprechen Sie bei Bedarf mit ihrer Hausbank über ein günstiges Finanzierungsdarlehen. Eine für das Bankgespräch hilfreiche Übersicht finden Sie in der Umsetzungshilfe auf der Seite „Informationen für die Hausbank“.
- Um den richtigen Handwerksbetrieb auszuwählen, sollten Sie für alle Bauleistungen mehrere Angebote einholen und vergleichen. Die Angebote sollten die geplanten Maßnahmen sowie Menge, Fabrikat und Merkmale des Baumaterials enthalten. Dabei sollten Sie den Firmen die exakte Materialstärke und -qualität mitteilen. Konkrete Angaben dazu finden Sie in Ihrer Umsetzungshilfe. Je detaillierter die Angebote sind, desto besser kann man ihre Qualität beurteilen und die richtige Entscheidung treffen. Gute Handwerksbetriebe können ihr Know-how durch Referenzen belegen. Lassen Sie sich diese zeigen.
- Schließen Sie mit der Firma Ihrer Wahl einen Bauvertrag ab. Im Bauvertrag werden die konkreten Leistungen beschrieben, ein Zeitplan mit verbindlichen Abnahmeterminen festgelegt, Zahlungsfristen und Mängelansprüche geregelt. Auch Fristen aus bewilligten Förderungen sollten dabei erfasst werden.
- Ich unterstütze Sie gerne bei der Baubegleitung. Diese wird in vielen Fällen gefördert: Die KfW übernimmt 50 % der Kosten, maximal 4.000 Euro. Bei der Baubegleitung wird die Baustelle mehrmals kontrolliert und der Baufortschritt dokumentiert. Damit kann eine qualitativ hochwertige Ausführung sichergestellt werden. Mithilfe eines sogenannten Blower-Door-Tests kann die Luftdichtheit des Gebäudes überprüft werden. Wann dieser idealerweise erfolgen sollte, damit eventuelle Mängel noch behoben werden können, ist in der Umsetzungshilfe beschrieben.
- Der Abschluss der Arbeiten sollte in einem Abnahmeprotokoll festgehalten werden. Darin wird die auftragsgemäße Umsetzung in der vereinbarten Qualität bestätigt. Darüber hinaus werden eventuelle Mängel und fehlerhafte Produkte benannt und Fristen für deren Beseitigung und Nachbesserung vereinbart.
- Ich empfehle Ihnen nach der Sanierung Ihren Energieverbrauch zu beobachten. Denn wer die eigenen Verbrauchsgewohnheiten kennt, weiß, wodurch Energie verbraucht wird und schafft so die Voraussetzung für neue Energiesparerefolge.

EINBINDUNG WEITERER PLANER UND SACHVERSTÄNDIGER

Der vorliegende Sanierungsfahrplan ist das Ergebnis Ihrer Energieberatung und ersetzt keine Ausführungsplanung. Bevor die Bauarbeiten zur Umsetzung der Maßnahmen beginnen, sollten Sie die Bauteile auf Schäden und Nutzbarkeit kontrollieren lassen. Hierfür empfehle ich Ihnen die Einbindung von:

- Architekt, Planung Umbaumaßnahmen
- Statiker, Kontrolle Dachstuhl auf Tragfähigkeit für Solaranlage
- Schornsteinfeger, Begutachtung Schornstein
- Holzschutzgutachter, Kontrolle Dachstuhl und Holzbalkendecken auf Holzschäden und Tragfähigkeit
- Fachplaner Haustechnik, Planung Lüftungsanlage

Figure 51: iSPF - your next steps (Source: BMWi)



Figure 52: iSPF - renovation roadmap (Source: BMWi)

Figure 53 includes useful details about concepts and energy requirements to increase the user's understanding of the renovation roadmap.

ERLÄUTERUNGEN ZU IHREM SANIERUNGSFAHRPLAN

ENDENERGIEBEDARF

Der Endenergiebedarf ist die berechnete Energiemenge, die der Anlagentechnik (Heizung, Warmwasser, Lüftung) zur Verfügung gestellt werden muss, um die festgelegte Rauminnentemperatur und die Erwärmung des Warmwassers sicherzustellen, inklusive der für den Betrieb der Anlagentechnik benötigten Hilfsenergie. Er beinhaltet auch die Energieverluste durch Erzeugung, Verteilung, Speicherung und Übergabe im Gebäude.

PRIMÄRENERGIEBEDARF

Der Primärenergiebedarf berücksichtigt neben dem Endenergiebedarf des Gebäudes auch den Energieaufwand für die vorgelagerten Prozessketten außerhalb des Gebäudes. Dazu gehören die Gewinnung, Aufbereitung, Umwandlung und Verteilung der jeweils eingesetzten Brennstoffe.

GEBÄUDENUTZFLÄCHE A_N

Gemäß Energieeinsparverordnung rechnerisch abgeleitete Fläche aus dem beheizten Gebäudevolumen. Sie dient im öffentlich-rechtlichen Nachweis als Bezugsfläche (auch Energiebezugsfläche) u.a. für End- und Primärenergiebedarf. Die im Sanierungsfahrplan gemachten Angaben zu Bedarfen, Kosten und CO₂-Emissionen beziehen sich auf die Gebäudenutzfläche.

WOHNFLÄCHE

Die Wohnfläche entspricht den Angaben des Eigentümers und wurde für diesen Sanierungsfahrplan nicht gemäß Wohnflächenverordnung oder anderen Rechtsvorschriften neu ermittelt.

ENERGIEKOSTEN

„Energiekosten heute“ beruhen auf dem Abgleich des berechneten Endenergiebedarfs mit dem individuellen Nutzerverhalten und den Klimafaktoren. Es wurden Ihre heutigen Energiepreise bzw. ein derzeit üblicher Energiepreis zu Grunde gelegt.

Energieträger	Strom-Mix	Erdgas	Energieträger 2	Energieträger 3
Grundpreis heute (brutto)	50,00 €/a	181,83 €/a	-	-
Arbeitspreis heute (brutto)	19,20 Cent/kWh	6,26 Cent/kWh	-	-

* Der Arbeitspreis bezieht sich auf den Heizwert.

„Energiekosten zukünftig“ beruhen auf dem Abgleich des berechneten Endenergiebedarfs mit dem zu erwartenden Nutzerverhalten. Für die Energiekosten wird der prognostizierte Energiepreis des jeweiligen Energieträgers für 2030 angenommen (Quelle: „Effizienzstrategie Gebäude“ der Bundesregierung 12/2015).

EINORDNUNG DER ENERGETISCHEN GESAMTBEWERTUNG DES HAUSES AUF DER FARBSKALA

	q_p in kWh/(m ² a)	Beschreibung
	<= 30	fortschrittlicher Standard
	<= 60	gesetzliche Anforderung an Neubauten
	<= 90	gesetzliche Anforderung an Neubauten Stand 2002/2009
	<= 130	teilsaniertes Gebäude
	<= 180	teilsaniertes oder unsaniertes Gebäude
	<= 230	teilsaniertes oder unsaniertes Gebäude
	> 230	teilsaniertes oder unsaniertes Gebäude

Figure 53: Explanation of your renovation roadmap (Source: BMWi)

Figure 54 and Figure 55 display one example of a detailed recommendation included in the iSP. The “measure package 1” in the example below includes information on benefits (e.g. warmer feet and lower heating bill), details on the measures, energy performance level and consumption before and after implementation, details on costs (labour and materials) and available subsidies, as well as explanations of the measure (see Figure 55).

MASSNAHMENPAKET 2

DAS BRINGT ES

- ✓ Ausgeglichenes Raumklima
- ✓ Besserer Hitzeschutz im Sommer
- ✓ Verminderung der Wärmeverluste über die Dachflächen

WANN / WARUM (AUSLÖSER)

Voraussichtlich 2021-2022, da Auszug der Kinder geplant



IHRE MASSNAHMEN IN DER ÜBERSICHT

Maßnahme	Ausführung	Energetische Bewertung	
		vorher	nachher
Dämmung Dach	18 cm (WLS 032)	●	●
Heizungsoptimierung*	hydraulischer Abgleich der Heizungsanlage	●	●
Qualitätssicherung & begleitende Maßnahmen		Erreichte Qualität	
Luftdichtheit*			
Wärmebrücken*			
Energiekennwerte			
Flächenbezogener Primärenergiebedarf		127 kWh/(m²a)	
Flächenbezogener Endenergiebedarf		112 kWh/(m²a)	
Kohlendioxid-Emissionen		24 kg/(m²a)	
Investitionskosten		davon Instandhaltung	Förderung**
	34.600 €		19.700 €
			--- €

* Details zu wiederkehrenden Maßnahmen finden Sie im Kapitel „Optimierung und Qualitätssicherung“

** Förderbetrag zum Zeitpunkt der Erstellung des Sanierungsfahrplans

Figure 54: iSP - detailed recommendation 1 (Source: BMWi)

DÄMMUNG DACH

KURZBESCHREIBUNG

18 cm Wärmedämmung der Wärmeleitstufe (WLS) 032 zwischen den Sparren

Nach Einbau der Dämmung weist das Dach einen U-Wert von $0,23 \text{ W}/(\text{m}^2\text{K})$ auf. Damit erfüllt das Dach die Anforderungen der heute geltenden Fassung der EnEV an Einzelbauteile. Aufgrund der vorhandenen Dachgauben ist eine zusätzliche Aufdachdämmung nicht möglich.

SO GEHT ES

Für die Sanierung der Dachflächen ihres Gebäudes wurde die Zwischensparrendämmung gewählt (vgl. Abb. Dachperspektive Zwischensparrendämmung). Damit die vorhandenen Innenverkleidungen nicht demontiert werden müssen, wird die Dämmung von der Außenseite angebracht. Dadurch entstehen für Sie keine Einschränkungen innerhalb des Hauses während der Ausführung.

Zum Einbringen des Dämmstoffes ist der Rückbau der Dacheindeckung und der alten Ausfachung erforderlich. Um die Sparrenhöhe der notwendigen Dämmstoffdicke anzupassen, müssen die Sparren verstärkt werden. Nach Einbau der Dampfbremsschicht und des luftdichten Anschlusses an die benachbarten Bauteile wird die Dämmung in die Sparrenzwischenräume lückenlos eingelegt, mit der Unterspannbahn geschützt und die Dacheindeckung erneuert (vgl. Abb. Querschnitt Zwischensparrendämmung).

ZU BEACHTEN

Im Zuge der Dacharbeiten wird der Dachüberstand bereits für die spätere Dämmung der Außenwände verbreitert. Die Dachflächendämmung sollte bis auf die Mauerkronen der aufgehenden Außenwände gezogen und für die Anschlussdämmung vorbereitet werden, um später Wärmebrücken zu vermeiden. Empfehlenswert ist der Einbau eines Dämmstreifens entlang der Mauerkrone. Damit lässt sich die Außenwanddämmung anschließen, ohne das bereits modernisierte Dach erneut anpassen zu müssen. Die Herstellung der luftdichten Schicht ist lückenlos umzusetzen. Besonderes Augenmerk ist auf den luftdichten Anschluss am Außenmauerwerk zu legen. Die Funktionstüchtigkeit der luftdichten Schicht sollte mittels

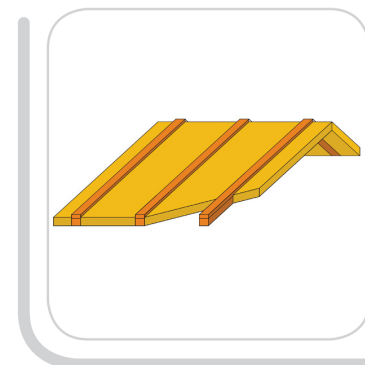

Prinzipskizze: Dachperspektive Zwischensparrendämmung

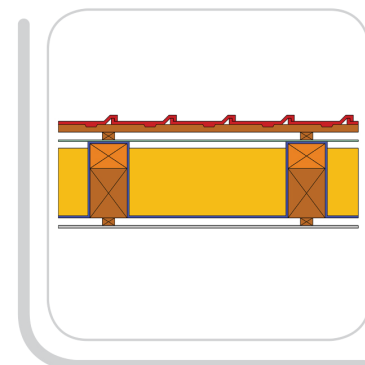

Prinzipskizze: Querschnitt Zwischensparrendämmung

Figure 55: iSFP - detailed recommendation 2 (Source: BMWi)



This project has received funding from the European Union's Horizon 2020 research and innovation programme under grant agreement N° 754045

www.ibroad-project.eu

